

# Inhoudsopgave Mijn Codeboek versie 3

<u>Codering</u>	<u>Deel</u>	<u>Pagina</u>
1612.....	2	20
6FEBRUARISCHRIFT .....	3	6
ACCOORDEN.....	4	11
AETHERIAN SCRIPT .....	4	4
AIRCRAFT MARSHALLING SIGNALS .....	5	4
ALBERTI CIPHER.....	1	13
ALCHEMY CODES.....	1	24
ALCHEMIE .....	5	3
ALCHEMICAL .....	5	27
ALIEN VISITOR.....	2	17
ALPHABET OF ANGELS .....	5	20
ALTERES FUTHARH .....	2	13
AMINOZUREN CODE-ZON .....	1	21
ANCIENT & CLASSIC GREEK ALPHABET.....	2	23
ANCIENT ALPHABET.....	2	6
ANCIENT AND WRAITH ALPHABETH.....	4	6
ANCIENT BERBER.....	3	16
ANCIENT BRANDOBIAN .....	2	8
ANCIENT LATIN ALPHABET .....	2	22
ANCIENT PRIMES .....	5	18
ANCIENT QUILL .....	5	22
ANGELIC SCRIPT.....	2	19
ANGELOID RUNES .....	5	20
ANGELSAKSICHEN RUNEN .....	2	13
ANGLE BRANDING SYSTEM .....	3	6
ANTIKER CODE.....	2	21
ARABISCH TELLEN.....	4	5
ARABISCHE CIJFERS .....	1	14
ARCADIAN ALPHABET.....	2	5
ARCADIAN CODE.....	3	13
ASHLEY ALPHABET .....	1	9
ATBASH (HEBREW) .....	3	15
ATBASH.....	3	15
ATH ALPHABET .....	2	5
ATH ALPHABET .....	3	21
ATLANTEAN ALPHABET.....	2	3
ATLANTEAN ALPHABET.....	4	6
ATLANTEAN .....	2	17
ATTITUDE INDICATOR .....	5	7
AUREBESH .....	3	19
AUREK-BESK ALPHABET.....	2	6
AYLEID.....	2	10
BABYLONISCHE CIJFERS.....	1	16
BACKSLASH .....	3	13
BACONIAN CIPHER .....	3	15
BALLET CODE .....	3	13
BARCODES .....	5	11

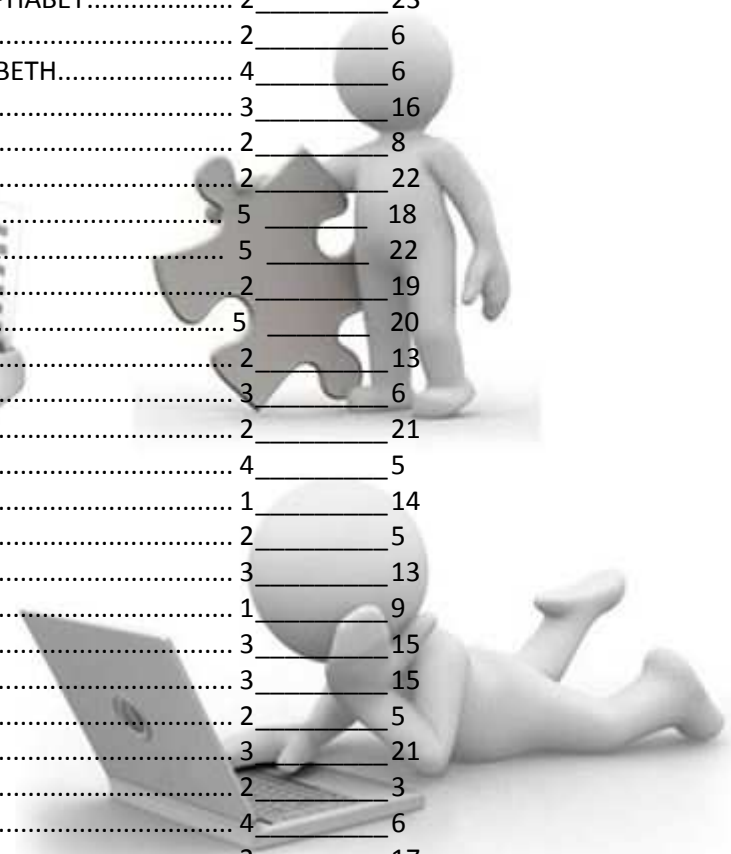

## **Codering** **Deel** **Pagina**

BASKETBALL REFEREE SIGNALS .....	5	9
BASIC CIPHERS OF THE MONKS .....	2	2
BASIC MILITARY HAND SIGNALS .....	5	6
BASINGSTOKE CIPHER .....	2	2
BAUDOT .....	3	12
BINAIRE GETALLEN .....	1	10
BIRDS ON A WIRE .....	3	21
BLORK ALFABET .....	5	12
BLOX .....	1	11
BOEKEN ALFABET .....	5	18
BOOM CODE .....	3	5
BRAHMI CIJFERS .....	1	15
BRAHMI TELLEN.....	3	2
BRILLE .....	1	18
BRITSE DIALECTEN .....	1	23
BROEKENCODE .....	5	11
CAESAR .....	3	15
CCITT.....	1	9
CHAPPE CODE.....	1	7
CHEROKEE ALFABET .....	1	21
CHINESE CIJFERS.....	1	15
CIRCULAR GALLIFREYAN .....	5	25
CIRTH ALFABET TOLKIEN.....	2	4
CISTERNIAN CIPHERS .....	2	3
CRANE SIGNALS .....	5	5
CODE 39.....	1	11
CODIGO ALFABET .....	3	18
COLORHONEY ALFABET .....	1	4
COLORTOKKI ALFABET .....	1	4
COMMON SITH .....	5	12
CONVENANT .....	5	2
COORGI COX ALFABET .....	3	6
CRICKET UMPIRE HAND SIGNALS .....	5	10
CTHULHUAIN FONT .....	5	17
CYBERTRONIAN .....	2	16
CYRILISCHE CIJFERS .....	1	14
CYRILLIC NUMBERS.....	2	22
D'NI.....	1	25
DAEDRIC (SKYRIM).....	2	7
DAGGER CODE .....	3	20
DANCING MAN (SHERLOCK HOLMES) .....	3	8
DANCING MEN .....	3	8
DECABIT .....	3	12
DEMON SCRIPT.....	2	19
DINGBATCAVE .....	4	8
DNI NUMERALS .....	2	24
DOTHRAKI (GAME OF THRONES) ATLANTEAN .....	2	9
DOTSIE .....	4	3
DOTSIES ALFABET .....	5	12
DRACHENSPRACHE .....	2	8

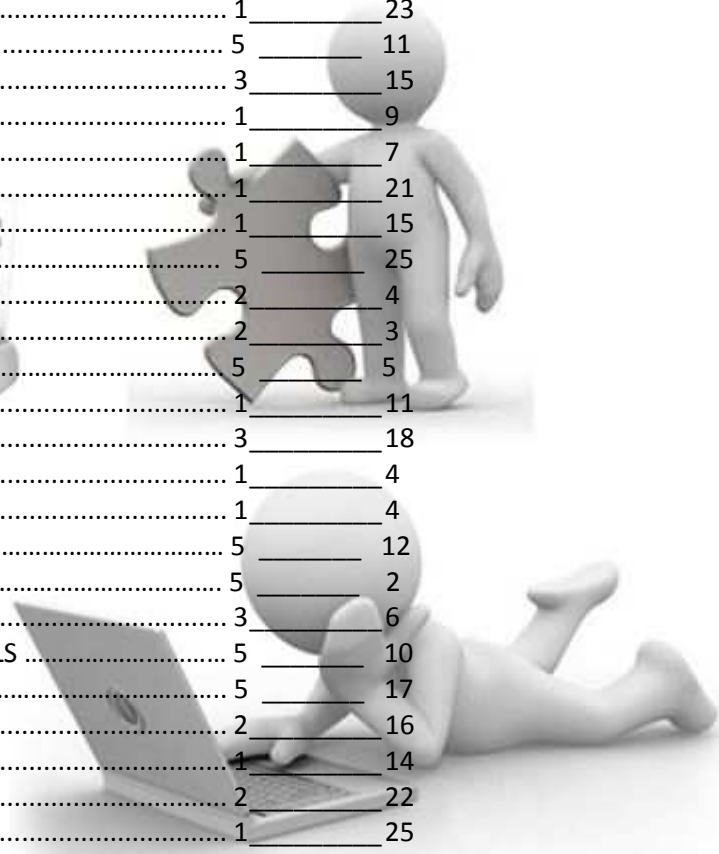

**Codering** **Deel** **Pagina**

DRACONIC ALPHABET.....	2	7
DRAGON RUNES .....	2	4
DRIEHOEKJES CODE .....	3	17
DROID .....	5	16
DSCRIPT ALPHABET.....	3	23
DTMF TOON CODE/VANITYCODE.....	1	10
DWEMER .....	2	10
EARLY CYRILLIC SCRIPT .....	2	22
EBCDIC .....	3	19
ELEMENTARIUM .....	5	19
ELITE ALPHABET .....	5	22
ELVISH ALPHABET .....	2	9
EMOTICONS.....	4	9
ENCHANTMENT TABLE CODE .....	2	18
ENOCHIAN .....	2	17
ERLKONINGSCHRIFT .....	3	8
EXTRA GALACTIC ALPHABET .....	5	19
FACE – IT.....	4	9
FALMER.....	2	10
FANTASIA ALFABET.....	3	20
FENICIERS ALFABET .....	1	22
FENICISCH.....	2	23
FEZ CODE .....	3	6
FICTIONAL ALPHABET .....	2	19
FINGERALPHABET .....	1	12
FONIC ALPHABET.....	2	6
FONIC LANGUAGE .....	4	8
FOOTBALL REFEREE SIGNALS .....	5	9
FREEMASON’S CIPHER.....	1	2
FUTHARKEN .....	2	12
FUTURAMA ALIEN ALPHABET.....	2	15
FUTURAMA CODE.....	3	21
GALLIFREAN ALPHABET .....	3	26
GALLIFREYAN ALPHABET .....	3	26
GALLIFREYAN .....	3	26
GARGISH & RUNIC ALPHABET .....	2	14
GEBITSCODE .....	3	11
GENREICH .....	4	8
GEONOSIAN .....	5	14
GEORGE WASHINGTON KEY .....	2	24
GERMANISCHE RUNEN .....	2	12
GLAGOLICA .....	3	17
GLAGOLICTIC ALPHABET.....	2	24
GLAGOLJICA ALPHABET .....	5	22
GLAGOLITISCH ALPHABET .....	3	10
GLAGOLITISCH TELLEN .....	3	9
GNOMISCH ALPHABET.....	2	7
GOTISCH RUNENALFABET .....	2	13
GRIEKS ALFABET .....	1	21
GRIEKS TELLEN.....	3	3

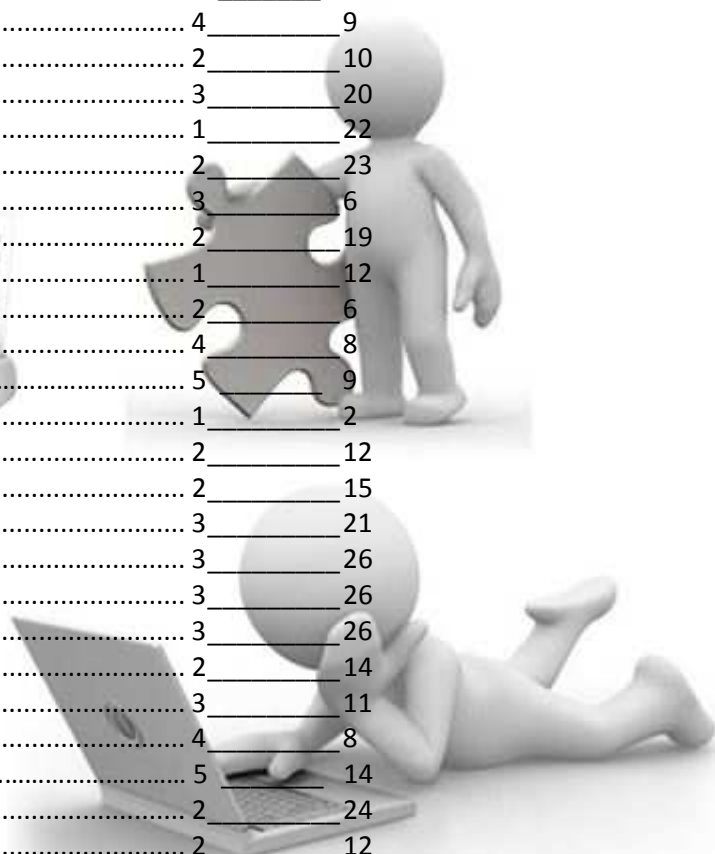

<b>Codering</b>	<b>Deel</b>	<b>Pagina</b>
GRIEKSE CIJFERS .....	1	16
HALO COVENANT ALPHABET .....	2	21
HALO FORERUNNER SYMBOLS .....	5	23
HANGEUL ALPHABET .....	3	9
HB3D.....	3	5
HEAIAIAANS.....	2	8
HEBREEUWS ALFABET .....	3	4
HEBREEUWSE CIJFERS .....	3	4
HEIDELBERGER CIPHERS.....	2	3
HENOCHISCH CODE .....	3	10
HEXAHUE CODE.....	1	23
HIERATISCH TELLEN.....	3	3
HIEROGLIEFEN .....	1	17
HINDI CIJFERS .....	1	14
HTLM KLEURCODES .....	1	3
HUMEUR.....	4	10
KEIHAN .....	4	7
HVD.....	3	20
HYLIAN ALPHABET .....	2	22
HYMMNOS ALPHABET .....	2	21
ILLUMINATI CODE .....	5	19
ILYTHIIRI ALPHABET .....	5	21
INDISCH TELLEN.....	3	2
INKUARE / MADOKA RUNES.....	2	14
JAPANS TELLEN.....	3	9
JAPANSE CIJFERS.....	1	16
JURERING TURNEN .....	5	10
KABOUTER ALFABET .....	2	25
KENNY CODE.....	3	11
KHAROSTHIL NUMBERS.....	3	23
KING WEN HEXAGRAM SEQUENCE.....	5	2
KITTAT .....	5	3
KIX-CODE .....	1	11
KLASSISCH RUNEN .....	2	11
KLINGON ALPHABET .....	2	15
KLOK ALFABET .....	3	13
KOREAN ALPHABET .....	3	9
KRYPTONIAN ALPHABET.....	2	16
LEETSPEAK .....	3	11
LEGEND OF ZELDA .....	5	23
LETTER-CIJFER-CIJFER .....	3	22
LORD OF THE RINGS .....	5	15
LUCAS ALPHABET.....	3	18
MAGE'S ALPHABET .....	5	24
MAGICODE .....	3	21
MALACHIM ALPHABET .....	2	19
MALACHIM ALPHABET 2 .....	5	23
MALACHIM FONT .....	5	27
MARAIN ALPHABET .....	1	26
MARITIEME SEINVLAGGEN.....	1	6

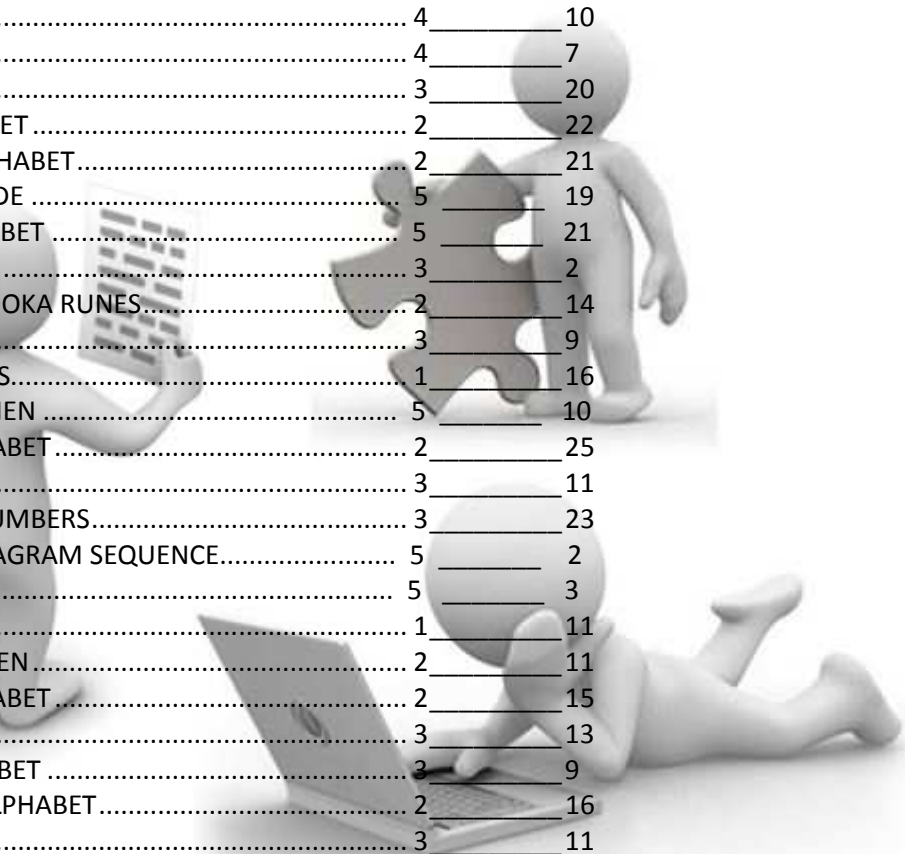

## **Codering** **Deel Pagina**

MARY QUEEN OF SCOTS.....	1	22
MASAFUMI'S ALPHABET .....	5	24
MASON CIPHERS.....	3	16
MASONIC CIPHER .....	1	2
MATORAN ALPHABET.....	2	20
MATRIXCODE .....	3	14
MAYA CIJFERS.....	1	14
MAYAN.....	5	13
MAZE CODE .....	2	25
MILITARY HAND SIGNALS .....	5	7
MINBARI .....	5	17
MINECRAFT.....	3	24
MNEMOMIC .....	1	8
MOBIELTJE.....	3	3
MOBILE CRANE HAND SIGNALS .....	5	5
MODERN CYRILLIC SCRIPT .....	2	23
MODERN HYLIAN NUMBERS .....	2	22
MOLENTAAL .....	4	3
MONDRUNEN .....	2	11
MONGOLIAN ALPHABET & NUMERALS .....	5	20
MOON ALFABET.....	3	20
MORSE ALFABET.....	1	8
MORSEIRDE CODE .....	5	16
MOTORCYCLE SIGNALS .....	5	4
MUZIEKNOTEN .....	3	19
NAGA ALPHABET .....	5	19
NAGARI CIJFERS.....	1	15
NAL-HUTTESE .....	5	16
NAVAJO CIJFER .....	1	13
NEW ZEALAND BRANDING SYSTEM .....	3	5
NICTOGRAPH ALPHABET .....	3	25
NOXILO .....	4	5
OGHAM 2.....	4	3
OGHAM ALPHABET.....	1	20
OGHAM.....	4	3
OLD HYLIAN SYLLABARY .....	2	6
OPHIDIAN RUNES .....	2	14
OUDE SYMBOLEN / SMEEDIJZEREN HEK .....	5	13
PC TOETSEN AMERIKAANS .....	3	3
PC TOETSEN .....	3	3
PERIODIEK SYSTEEM.....	1	19
PIGPEN CIPHER VARIATION.....	1	2
PIGPEN CIPHER.....	1	2
PIPELINE CODE.....	3	8
PLANET .....	4	7
PLAYING CARDS.....	4	10
POLYBIUS (5 und 6).....	3	10
POKEMON .....	5	14
POOL BALLEN.....	3	7
POSTNET .....	4	7

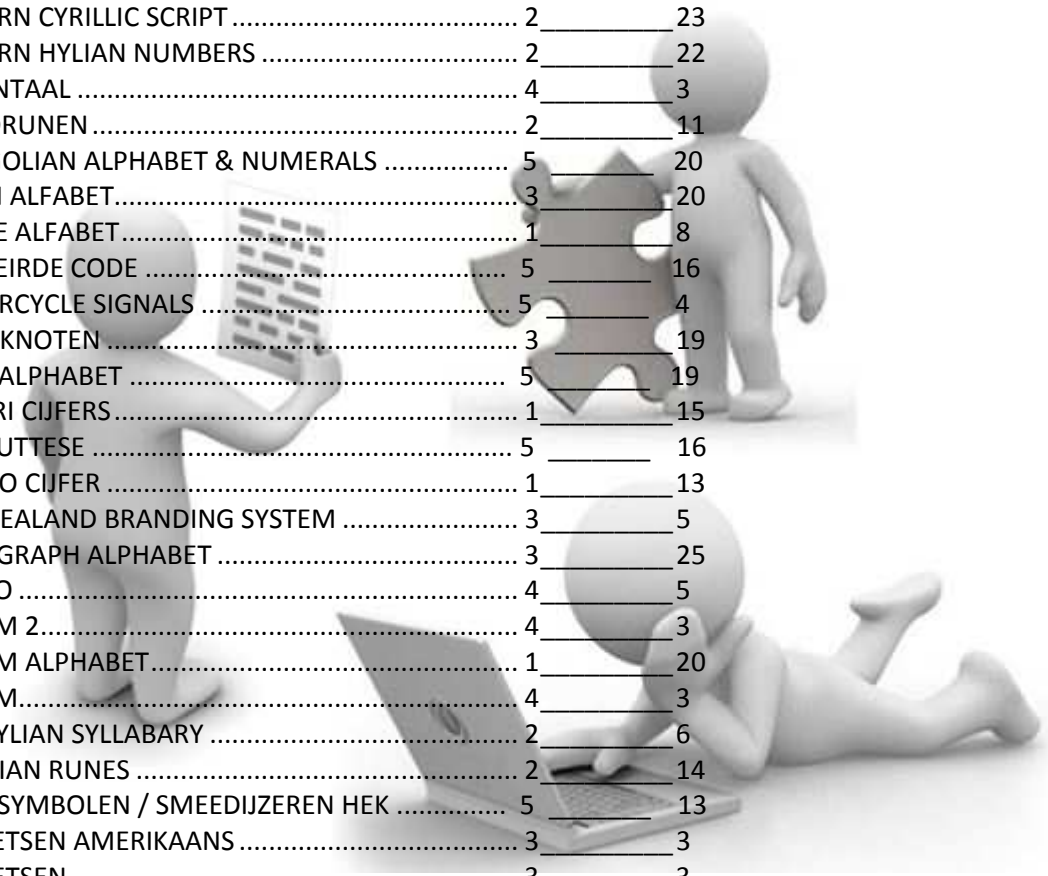

<b>Codering</b>	<b>Deel</b>	<b>Pagina</b>
PREUSSISCHE TELEGRAPHALFABET .....	1	11
PROTO SINAITISCH .....	5	2
PRIEMGETALLEN.....	1	22
PRECURSOR ALPHABET.....	5	24
PUZZELCODE.....	1	20
PYRAMID CIPHER.....	1	3
QUADOO ALPHABET .....	1	20
QUIK SCRIPT.....	3	23
RAUME CODE .....	3	25
RED HERRING .....	5	10
REKENMACHINE .....	1	22
REUSSER'S TELEGRAPH ALFABET.....	1	7
RIDDERS EN JONKVROUWEN .....	5	14
ROMEINSE CIJFERS .....	1	14
ROMEINSE GETALLEN .....	3	9
ROMULAN ALPHABET.....	2	15
ROSICRUCIAN CIPHER.....	1	2
ROVAS-SVABVAN RUNEN .....	2	12
RUNES ALPHABET 1889 .....	2	10
SAN LUCA CODE.....	4	6
SANSKRIT CIJFERS .....	3	16
SARATI ALPHABET TOLKIEN.....	2	4
SCRABBLE (NEDERLANDS) .....	5	14
SECTION AND PLATOON FIELD SIGNALS .....	5	8
SEGMENTEN VOOR CIJFERS.....	1	20
SEMAPHORE ALPHABET .....	1	5
SEMAPHORE/CLOCK ALPHABET .....	3	14
SHADOW.....	4	4
SHADOWKAN.....	4	4
SHORTHAND (ENGELS) .....	5	22
SHUTTERS TELEGRAPH CODE .....	1	7
SITH PROPHECY .....	5	15
SKY ALPHABET .....	2	8
SKYRIM DRAGON CIJFERS.....	2	8
SKYRIM .....	2	8
SKYRIM'S DRAGON ALPHABET .....	2	8
SOCCER / VOETBAL.....	4	2
SOLRESOL .....	1	18
SPACE INVADERS .....	2	17
SPECIALE TEKENS ARABISCH .....	4	8
SPECIALE TEKENS.....	4	5
SPINTYPE.....	3	10
STANDARD CISTERNIAN .....	2	3
STANDARD GALACTIC ALPHABET .....	2	15/18/20
STARWARS ALPHABET .....	2	18
STIPPELCODE ALFABET .....	1	10
SYMBOLS .....	1	26
T 8 .....	3	25
TAMIL CIJFERS .....	1	14
TEK BIN .....	3	7

## **Codering** **Deel** **Pagina**

TELEFOON ALFABET.....	1	7
TELEPHONE ALPHABET.....	1	6
TEMPLARS CIPHER.....	1	3
TENCTONESE ALPHABET.....	2	20
TENGWAR (ELVISH).....	2	7
TENGWARE CIJFERS.....	3	11
TERESIAN.....	5	17
THAI ALPHABET.....	5	21
THE ONE FOR THE DRAGON.....	2	18
THEBAN ALPHABET.....	3	2
THEBAN SCRIPT.....	3	2
THEROPODA.....	5	17
THREE SQUARES CIPHER.....	2	26
TREE ALPHABET.....	5	24
TIC-TAC-TOE CIPHER.....	1	2
TIFINAG (VIKING) ALPHABET.....	4	4
TIFINAGH.....	3	14
TIMES NEW VIOZIAN.....	3	22
TOLKIENS SCRIPTS.....	2	5
TOMTOM.....	3	12
TRADE FEDERATION.....	5	15
TRANSISTOR KLEUREN.....	1	22
TRAUMANIAANS.....	3	17
UNITOLOGY ALPHABET.....	1	23
UNITOLOGY.....	2	18
UNITOLOGY.....	5	22
URDU CIJFERS.....	3	16
URUK RUNES ALPHABET TOLKIEN.....	2	4
UTOPIA.....	1	21
UTOPIAN ALPHABET.....	2	20
VANITY (OF SMS) CODE.....	1	10
ROT 13.....	1	19
VERFKLEUREN.....	1	23
VERTICAAL SCHRIFT.....	1	19
VESPERIA ALPHABET.....	4	7
VESPERIAN ALPHABET.....	5	26
VINGERALFABET.....	1	12
VIOZIAANS.....	3	7
VIOZIAN.....	3	22
VISITORS ALPHABET.....	2	16
VLAGGENSEINEN.....	1	5
VOLLEYBALL SIGNALS.....	5	10
VULCANSCHRIFT.....	5	15
WEBDINGS.....	1	26
WEBSCHRIFT.....	3	18
WINGDINGS.....	1	25
XR ALPHABET.....	5	23
YINYANG ALPHALINES.....	2	26
ZAMORISCHE GETALLEN.....	3	3
ZENTLARDY ALPHABET.....	2	20

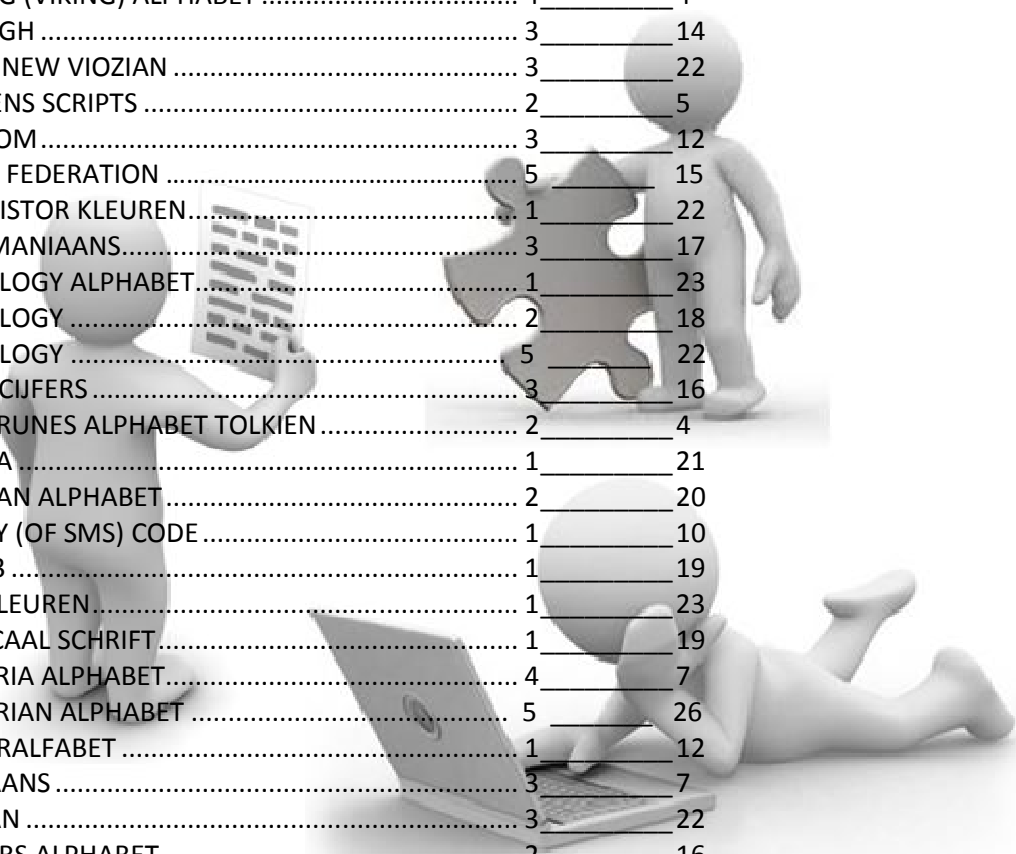

<b>Codering</b>	<b>Deel</b>	<b>Pagina</b>
ZODIAK.....	2	16
ZORAN ALPHABET .....	5	26





# MIJN CODEBOEK 3.1

## deel 1



**PIGPEN CIPHER**

**MASONIC CIPHER**

**FREEMASON'S CIPHER**

**ROSICRUCIAN CIPHER**

**TIC-TAC-TOE CIPHER**

**FREEMASON'S CIPHER**

**(VARIATION FROM ASSASSINS CREED II)**

**PIGPEN CIPHER VARIATION**

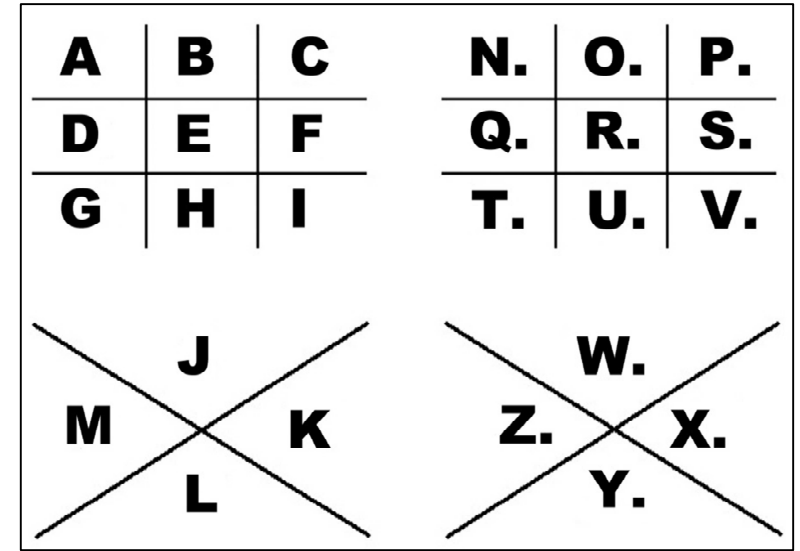
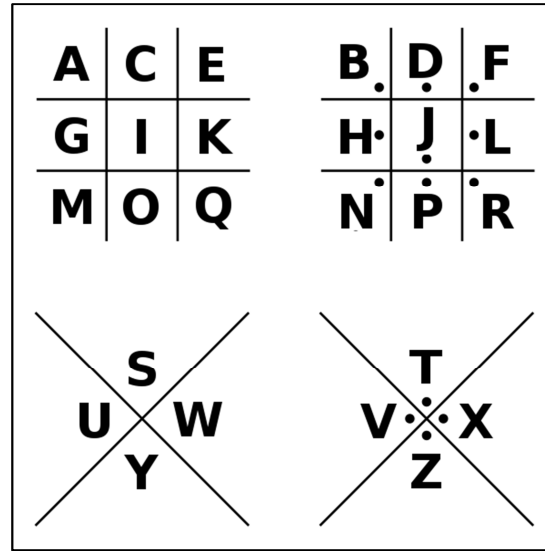
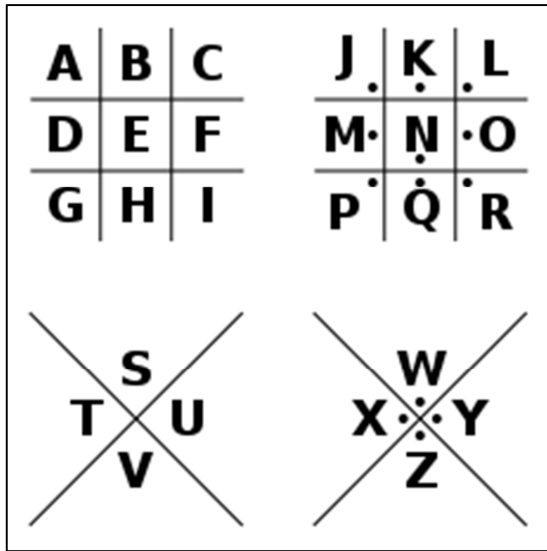

**PIGPEN CIPHER VARIATION**

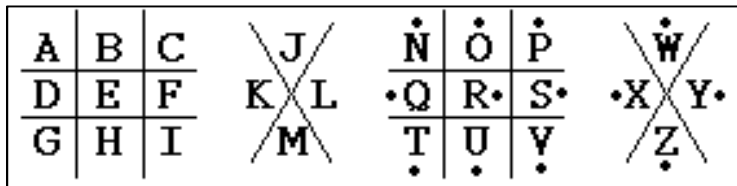

**PIGPEN CIPHER VARIATION**

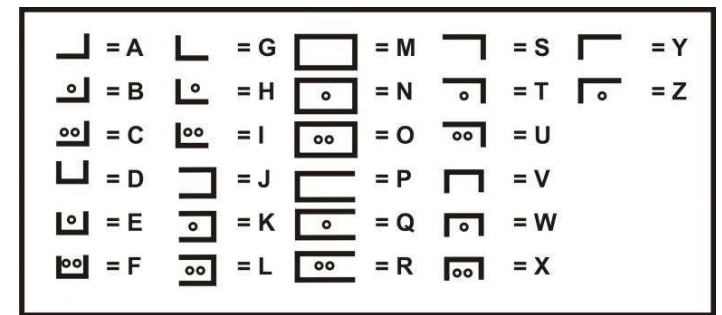
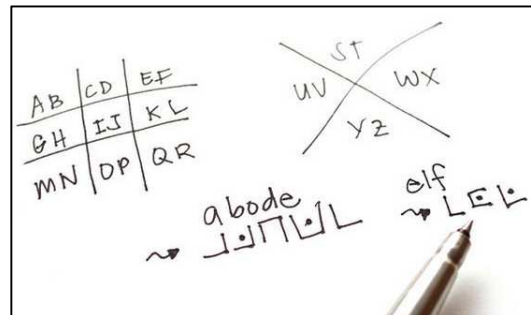

## TEMPLARS CIPHER

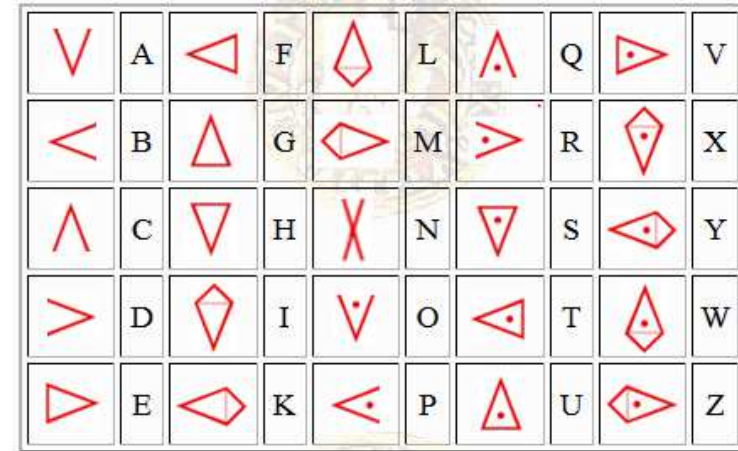
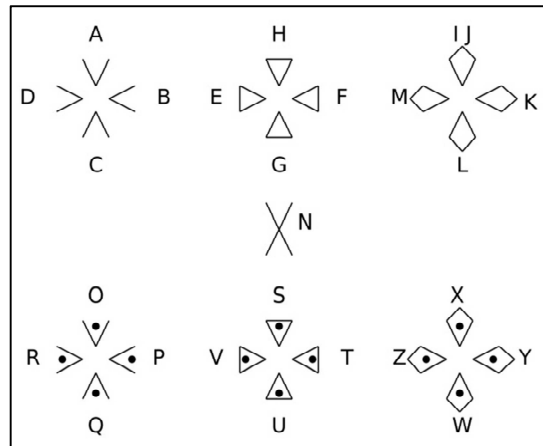
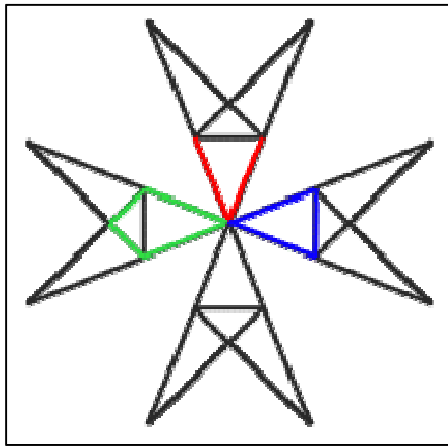

## HTLM KLEURCODES

Color Name	Color Code	Color Name	Color Code
Red	#FF0000	White	#FFFFFF
Cyan	#00FFFF	Silver	#C0C0C0
Blue	#0000FF	Gray or Grey	#808080
DarkBlue	#0000A0	Black	#000000
LightBlue	#ADD8E6	Orange	#FFA500
Purple	#800080	Brown	#A52A2A
Yellow	#FFFF00	Maroon	#800000
Lime	#00FF00	Green	#008000
Magenta	#FF00FF	Olive	#808000

MEER KLEUREN <http://www.computerhope.com/htmcolor.htm#brown>

## PYRAMID CIPHER

**PYRAMID CIPHER & ORDER 5 MAGIC SQUARE**

A	B	C	D	E
F	G	H	I	K
L	M	N	O	P
Q	R	S	T	U
V	W	X	Y	Z

E				
D	K			
C	I	P		
B	H	O	U	
A	G	N	T	Z
F	M	S	Y	
L	R	X		
Q	W			
V				

C	Q	I	W	P
U	H	V	O	B
G	Z	N	A	T
Y	M	E	S	F
L	D	R	K	X

1	2	3	4	5
6	7	8	9	10
11	12	13	14	15
16	17	18	19	20
21	22	23	24	25

5				
4	10			
3	9	15		
2	8	14	20	
1	7	13	19	25
6	12	18	24	
11	17	23		
16	22			
21				

3	16	9	22	15	65
20	8	21	14	2	65
7	25	13	1	19	65
24	12	5	18	6	65
11	4	17	10	23	65
65	65	65	65	65	65

Dan Thomasson, March 14, 2004

## COLORHONEY ALPHABET

Individual Case

Word Case

Light 

Dark 





































Honey



Honey Block

ColorHoney Alphabet

Easy Guide

					
E	F	G	H		
					
N	I	J	K	L	M
					
		U	V	W	X
					
		Z	Y		
					
	D	C	B	A	
					
T	S	R	Q	P	O

## COLORTOKKI ALPHABET

Individual Case

Word Case

Light 

Dark 





































Gui



Gui Block

ColorTokki Alphabet

Easy Guide

					
E	F	G	H		
					
N	I	J	K	L	M
					
		U	V	W	X
					
		Z	Y		
					
	D	C	B	A	
					
T	S	R	Q	P	O

# SEMAPHORE ALPHABET / VLAGGENSEINEN

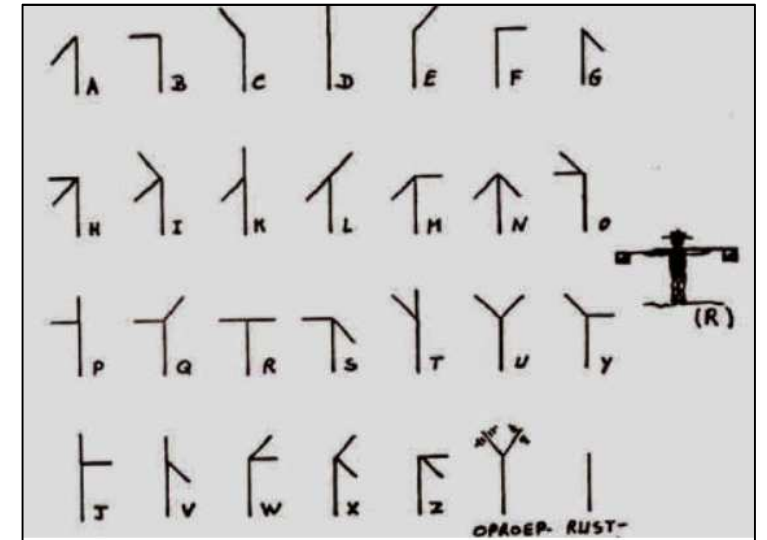
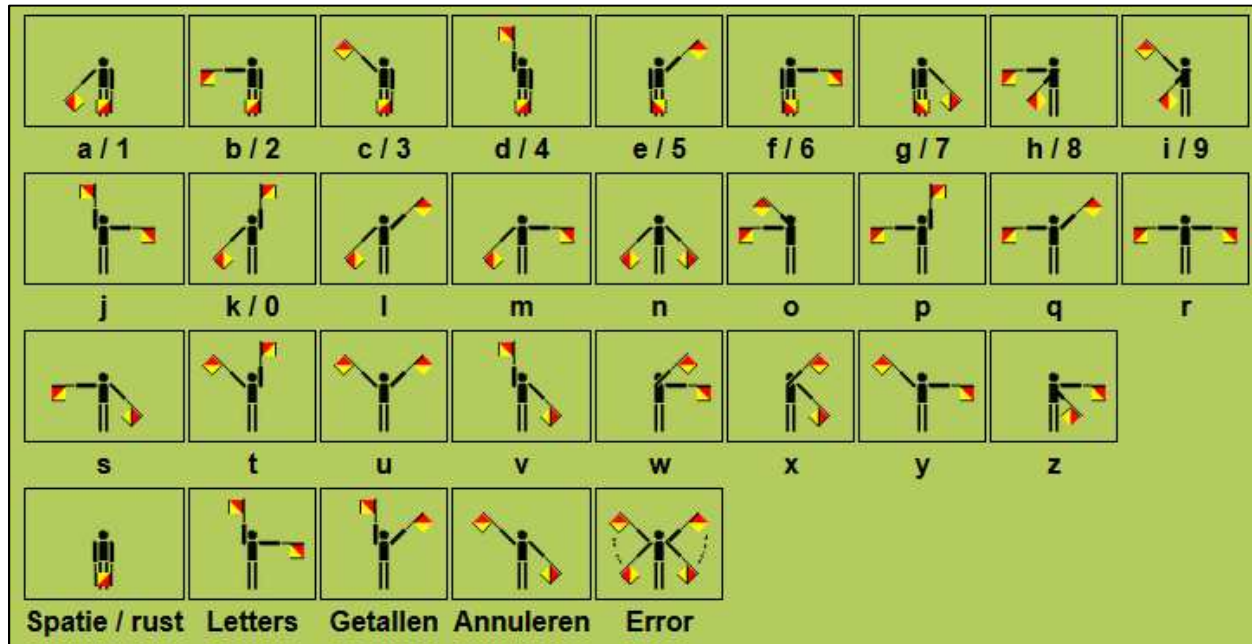
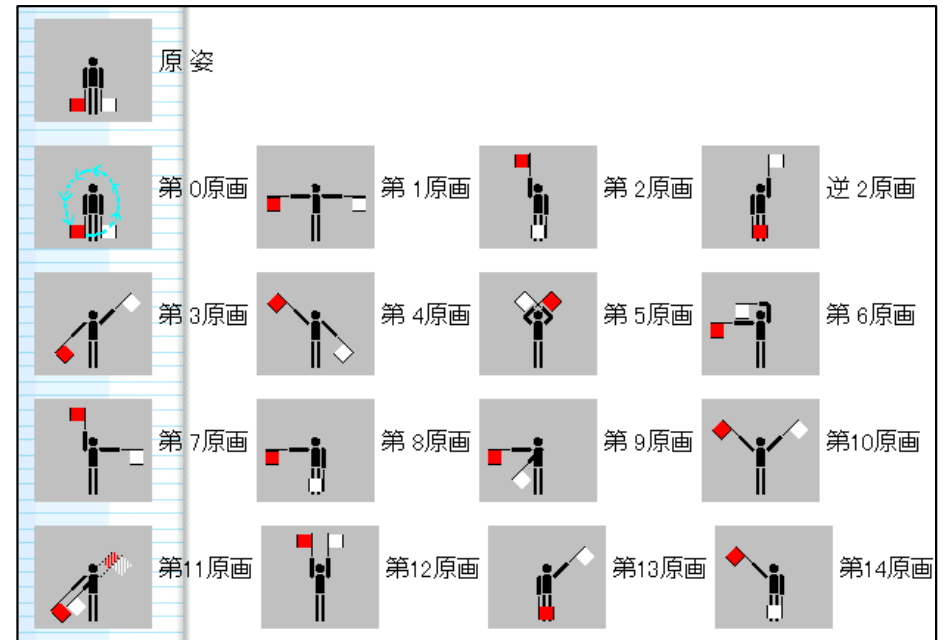
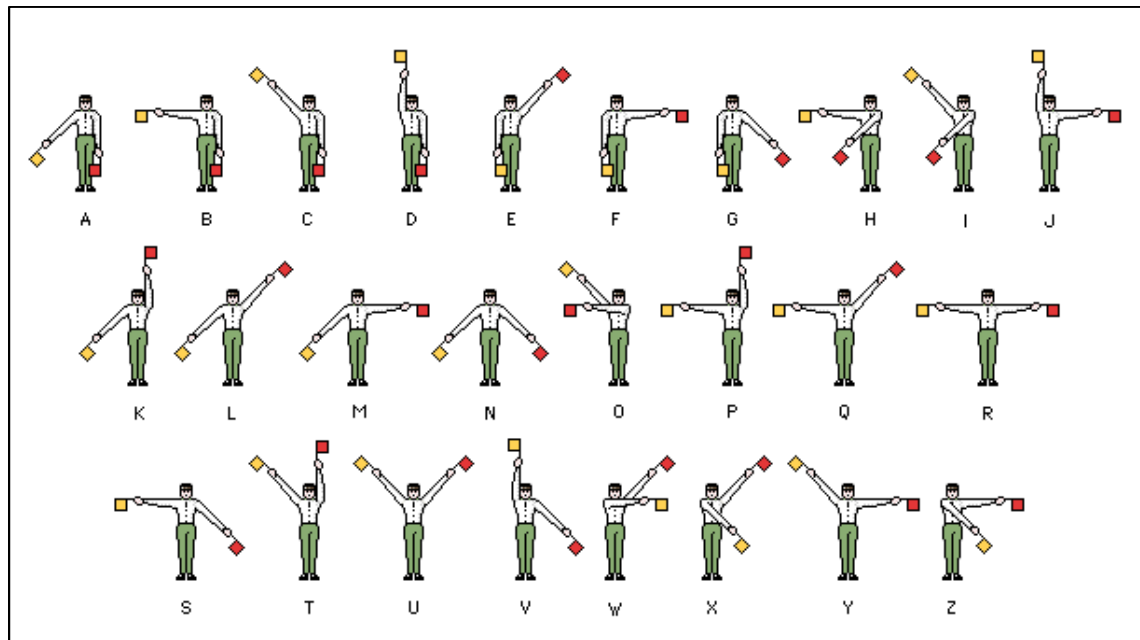

# MARITIEME SEINVLAGGEN

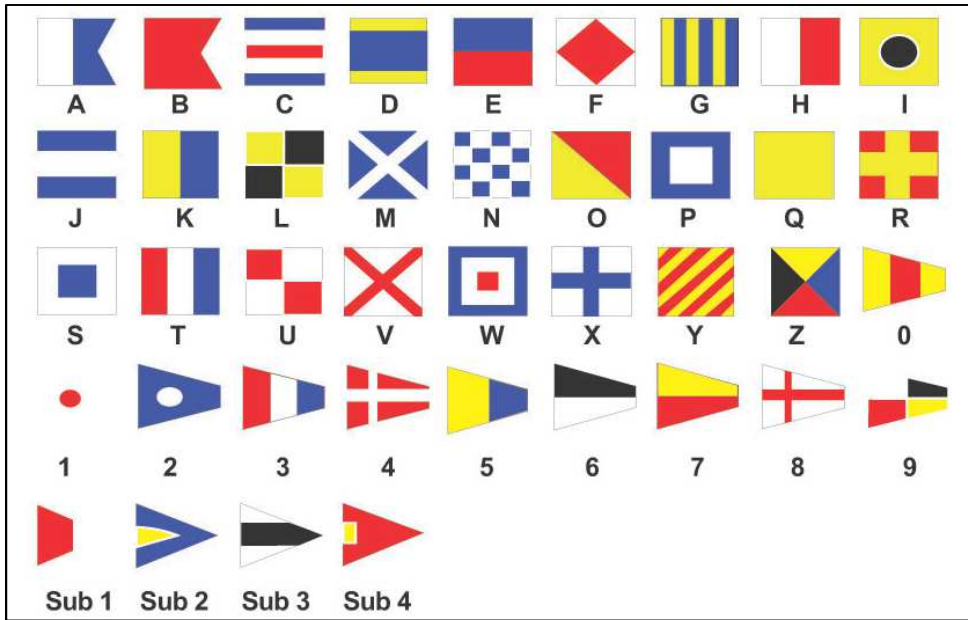

# THELEPHONE ALPHABET



## TELEFOON ALFABET

A - Alfa	N - November
B - Bravo	O - Oscar
C - Charlie	P - Papa
D - Delta	Q - Quebec
E - Echo	R - Romeo
F - Foxtrot	S - Sierra
G - Golf	T - Tango
H - Hotel	U - Uniform
I - India	V - Victor
J - Juliet	W - Whiskey
K - Kilo	X - X-Ray
L - Lima	Y - Yankee
M - Mike	Z - Zulu

## SHUTTERS TELEGRAPH CODE

A	B	C	D	E	F	G	H	I	J	K	L	M	N	O
P	Q	R	S	T	U	V	W	X	Y	Z	Ä	Ö	Ü	!
,	.	0	1	2	3	4	5	6	7	8	9			

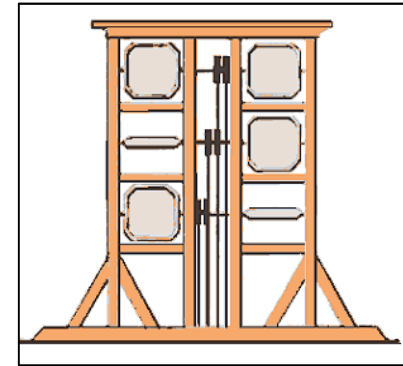

## CHAPPE CODE

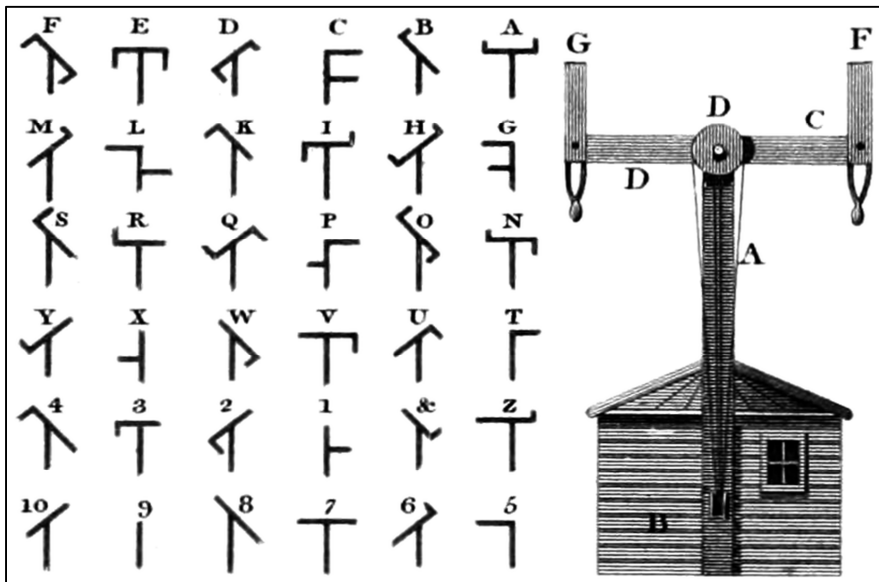

## REUSSER'S TELEGRAPH ALFABET

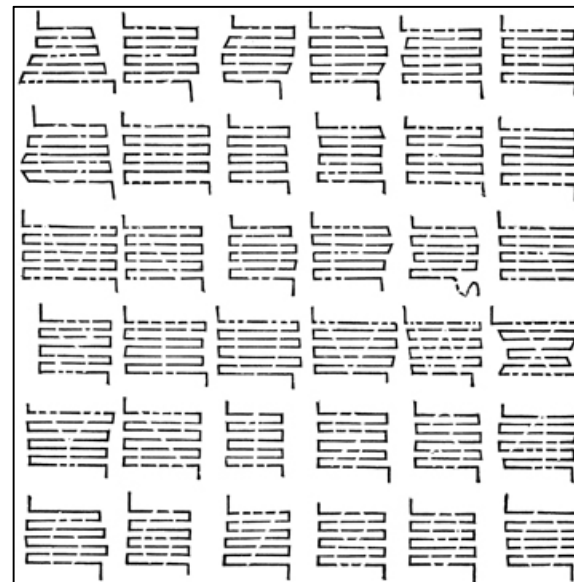

# MORSE ALFABET

.-	A	---.	G	--	M	...S	S	-.--	Y
-...	B	....	H	-.N	N	-T	T	--..	Z
-.-.	C	..I	I	---O	O	..-U	U		
-..D	D	.---J	J	.--.P	P	...-V	V		
.E	E	-.K	K	--.-Q	Q	.--W	W		
..-F	F	..L	L	.-R	R	-..-X	X		

.----	1	-.....	6
..---	2	--....	7
...--	3	---...	8
....-	4	-----	9
.....	5	-----	0

	American (Morse)	Continental (Gerke)	International (ITU)
A	.-	..-.	.-
Ä		..-.-.	
B	-...	-...-	-...
C	-.-.	-.-.-	-.-.
CH		..-.-.-	
D	-..	-..-	-..
E	.	..	.
F	.-.-.	.-.-.-	.-.-.
G	---.	---.	---.
H	....	....	....
I	..	..	..
J	.---	.---	.---
K	-.N	-.N	-.N
L	.-..	.-..	.-..
M	--	--	--
N	-.N	-.N	-.N
O	---	---	---
Ö		..-.-.	
P	.-.-.	.-.-.-	.-.-.
Q	-.-.	-.-.-	-.-.
R	.-.	.-.	.-.
S	...S	...S	...S
T	-T	-T	-T
U	..-U	..-U	..-U
Ü		..-.-.	
V	...-V	...-V	...-V
W	..-W	..-W	..-W
X	-..-X	-..-X	-..-X
Y	-.--Y	-.--Y	-.--Y
Z	--..Z	--..Z	--..Z
1	.----	.----	.----
2	..---	..---	..---
3	...--	...--	...--
4	....-	....-	....-
5	.....	.....	.....
6			
7			
8			
9			
0	-----	-----	-----
0 (alt)	-----	-----	-----

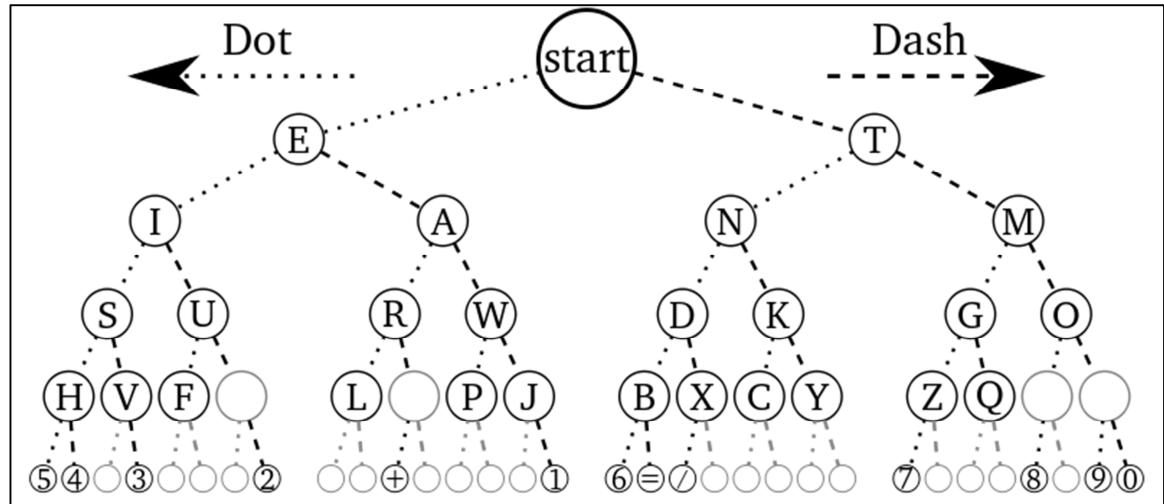

## MNEMONOMIC (EARLY MORSE) ALPHABET

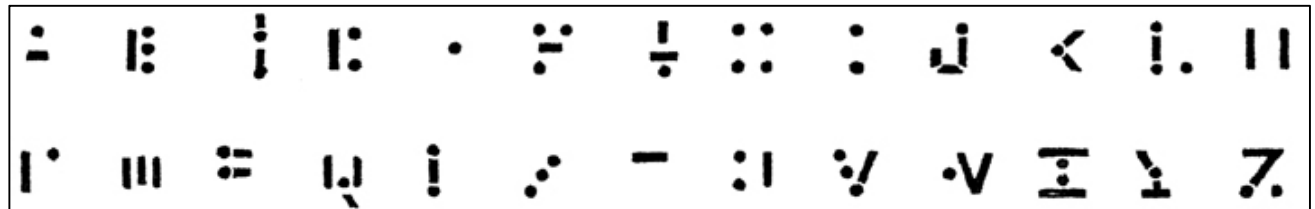



# MNEMONIC (EARLY MORSE) ALPHABET

Remade by Fattredd

<http://www.learnmorsecode.info/2010/12/a-cool-new-way-to-learn-morse-code/>

# CCITT

### Internationales Telegrafenalphabet Nr. 2 (CCITT)

CCITT Nr.	1	2	3	4	5	6	7	8	9	10	11	12	13	14	15	16	17	18	19	20	21	22	23	24	25	26	27	28	29	30	31	32			
Buchstabenreihe	A	B	C	D	E	F	G	H	I	J	K	L	M	N	O	P	Q	R	S	T	U	V	W	X	Y	Z	A...	1...	Zwr						
Zeichenreihe	-	?	:	+	3				8	Ⓜ	(	)	.	,	9	0	1	4	'	5	7	=	2	/	6	+	<	≡	A...	1...	Zwr				
Anlaufschritt																																			
Schrittgruppe	1	●	●	●	●	●				●	●										●														
	2	●								●	●	●	●									●	●	●	●										
	3										●	●	●	●	●	●	●	●	●	●	●	●	●	●	●	●	●	●	●	●	●	●	●	●	
	4										●	●	●	●	●	●	●	●	●	●	●	●	●	●	●	●	●	●	●	●	●	●	●	●	●
	5										●	●	●	●	●	●	●	●	●	●	●	●	●	●	●	●	●	●	●	●	●	●	●	●	●
Sperrschr. 1/2 fach	●	●	●	●	●	●	●	●	●	●	●	●	●	●	●	●	●	●	●	●	●	●	●	●	●	●	●	●	●	●	●	●	●	●	●

Pausenschritt

Stromschritt

Buchstabenumschaltung

Zifferumschaltung

Zwischenraum

Klingel

Wagenrücklauf

Zeilenvorschub

Wer da?

Nur für innerstaatlichen Betrieb

SIEMENS

# CCITT

# ASHLEY ALPHABET

## BINAIRE & HEXADECIMALE GETALLEN

Decimaal	Binair	Hexadeci- maal
1	1	1
2	10	2
3	11	3
4	100	4
5	101	5
6	110	6
7	111	7
8	1000	8
9	1001	9
10	1010	A

Decimaal	Binair	Hexadeci- maal
11	1011	B
12	1100	C
13	1101	D
14	1110	E
15	1111	F
16	10000	10
17	10001	11
100	01100100	64
255	11111111	FF
256	100000000	100

## BINAIRE GETALLEN OP JE VINGERS TELLEN

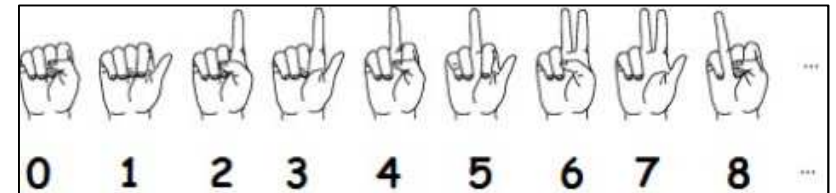

### BINAIRE GETALLEN TOOL

<http://wiskunde.ebrodesign.com/index.php?gr=7&id=69>

### GETALLENTOOL (binair-decimal-octal-duodecimal-hexadecimal-en meer)

[http://www.datedial.com/datnumber\\_base\\_converter.asp](http://www.datedial.com/datnumber_base_converter.asp)

<http://www.cleavebooks.co.uk/scol/calnumba.htm>

## VANITY (OF SMS) CODE



## DTMF TOON CODE/VANITYCODE

	Spalte 1 1209 Hz	Spalte 2 1336 Hz	Spalte 3 1477 Hz	Spalte 4 1633 Hz
Zeile 1 697 Hz	1	2 abc	3 def	A
Zeile 2 770 Hz	4 ghi	5 jkl	6 mno	B
Zeile 3 852 Hz	7 pqrs	8 tuv	9 wxyz	C
Zeile 4 941 Hz	*	0	#	D

## STIPPELCODE ALFABET

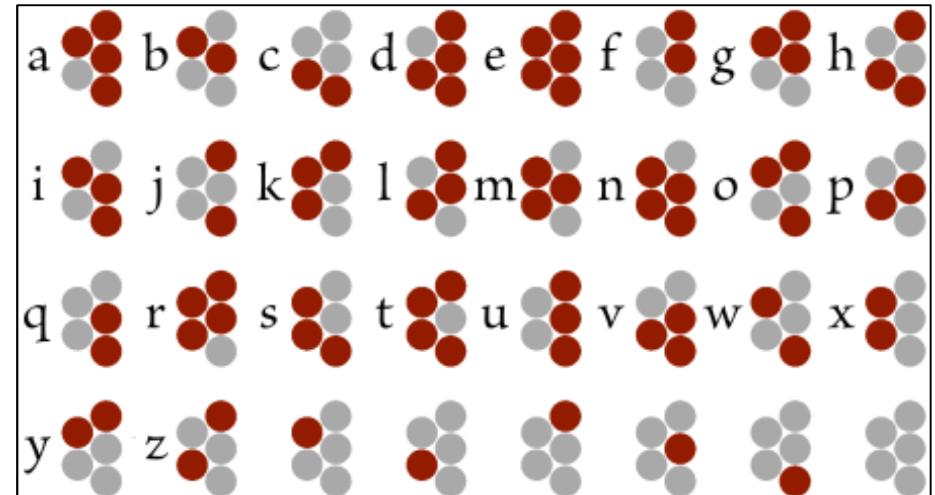



# VINGERALFABET



# FINGERALPHABET

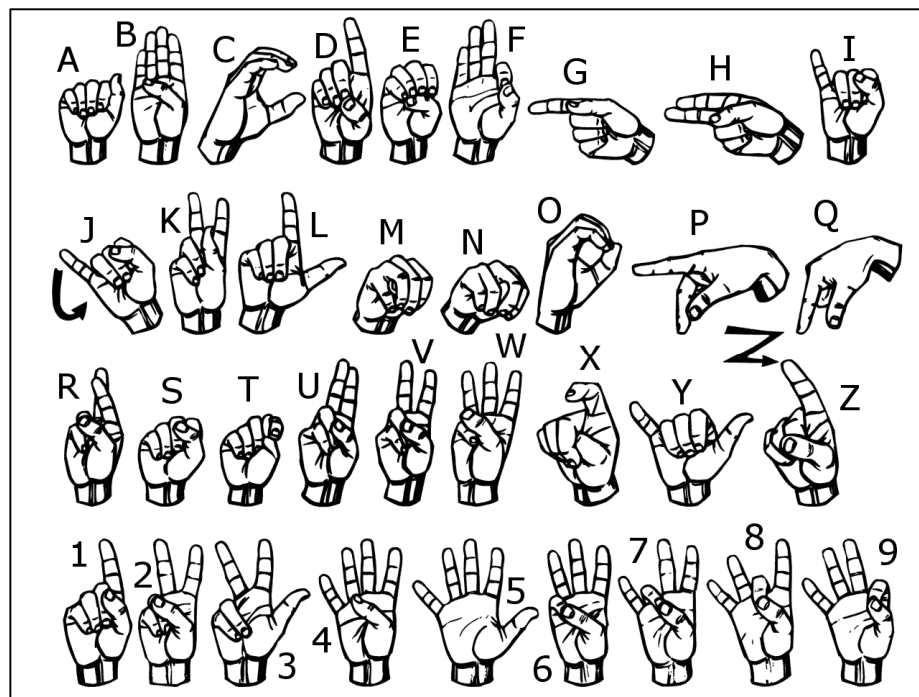
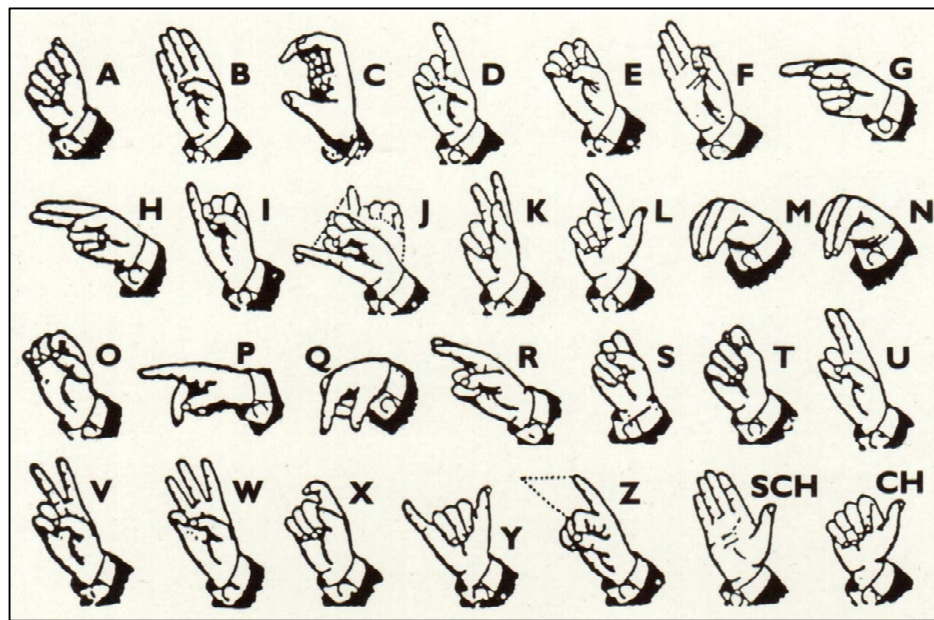

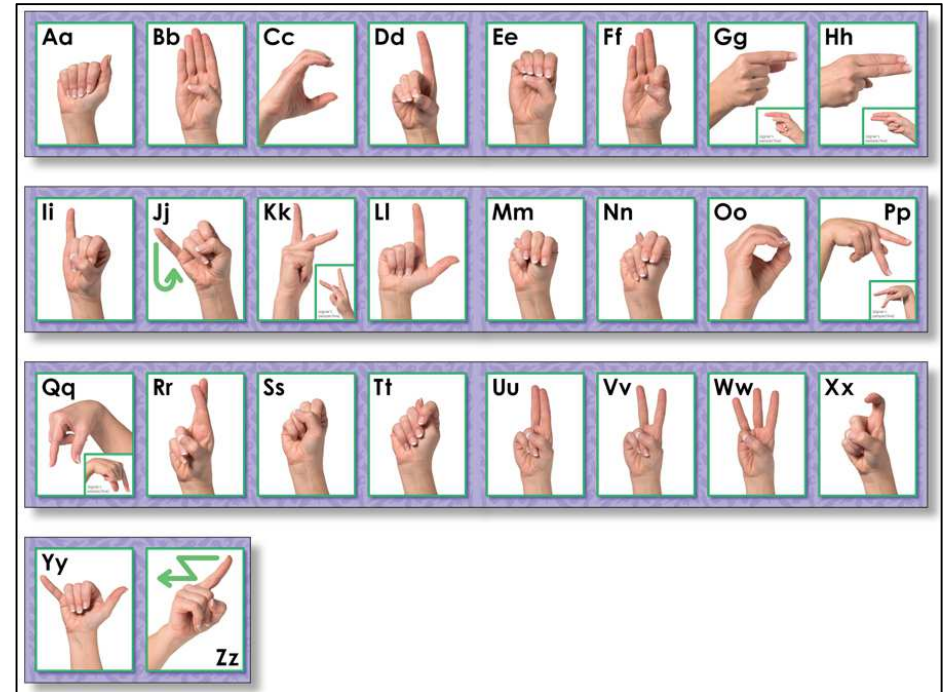

## ALBERTI CIPHER

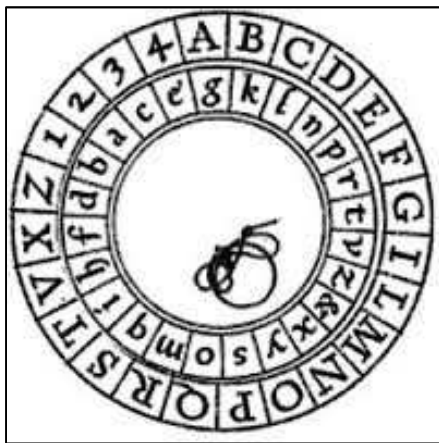

[http://www.cryptool-online.org/index.php?option=com\\_content&view=article&id=127&Itemid=150&lang=en](http://www.cryptool-online.org/index.php?option=com_content&view=article&id=127&Itemid=150&lang=en)

## NAVAJO CIJFER

A	Ant	Wol-lachee	N	Nut	Nesh-chee
B	Bear	Shush	O	Owl	Ne-ahs-jsh
C	Cat	Moasi	P	Pig	Bi-sodih
D	Deer	Be	Q	Quiver	Ca-yeilth
E	Elk	Dzeh	R	Rabbit	Gah
F	Fox	Ma-e	S	Sheep	Dibeh
G	Goat	Klizzie	T	Turkey	Than-zie
H	Horse	Lin	U	Ute	No-da-ih
I	Ice	Tkin	V	Victor	A-keh-di-glini
J	Jackass	Tkele-cho-gi	W	Weasel	Gloe-ih
K	Kid	Klizzie-yazzi	X	Cross	Al-an-as-dzoh
L	Lamb	Dibeh-yazzi	Y	Yucca	Tsah-as-zih
M	Mouse	Na-as-tso-si	Z	Zinc	Bseh-do-gliz

## MAYA CIJFERS

0	1	2	3	4
5	6	7	8	9
10	11	12	13	14
15	16	17	18	19

Rang 4		19 x 8000	152000
Rang 3		6 x 400	2400
Rang 2		0 x 20	000
Rang 1		8 x 1	8
			<b>154408</b>

0	1	2	3	4	360er					
5	6	7	8	9						
10	11	12	13	14				20er		
15	16	17	18	19						
								1er		
						32	389	4645		

## ARABISCHE/HINDI/CHINEES/TAMIL CIJFERS

Arabisch	0	1	2	3	4	5	6	7	8	9
Arabisch-Indisch	•	١	٢	٣	٤	٥	٦	٧	٨	٩
Oost Arabisch-Indisch (Perzisch en Urdu)	•	۱	۲	۳	۴	۵	۶	۷	۸	۹
Devanagari (Hindi)	०	१	२	३	४	५	६	७	८	९
Chinees	零	一	二	三	四	五	六	七	八	九
Tamil		௧	௨	௩	௪	௫	௬	௭	௮	௯

## CYRILISCHE CIJFERS

eenheden	tientallen	honderden
A 1	І 10	Р 100
B 2	К 20	С 200
Г 3	Л 30	Т 300
Д 4	М 40	У 400
Є 5	Н 50	Ф 500
Ѕ 6	Ѡ 60	Х 600
З 7	О 70	Ψ 700
И 8	П 80	Ѡ 800
Ө 9	Ч 90	Ц 900

## ROMEINSE CIJFERS

Romeins cijfer	betekenis
I	1
V	5
X	10
L	50
C	100
D	500
M	1000

## CHINESE CIJFERS

karakter (traditioneel)	karakter (vereenvoudigd)	formeel (traditioneel)	formeel (vereenvoudigd)	waarde	pinyin
零 / 〇	零 / 〇	零	零	nul	líng
一	一	壹	壹	een	yī
二 / 兩	二 / 两	貳	貳	twee	èr / liǎng
三	三	叁	叁	drie	sān
四	四	肆	肆	vier	sì
五	五	伍	伍	vijf	wǔ
六	六	陸	陆	zes	liù
七	七	柒	柒	zeven	qī
八	八	捌	捌	acht	bā
九	九	玖	玖	negen	jiǔ
十	十	拾	拾	tien	shí
百	百	佰	佰	honderd	bǎi
千	千	仟	仟	duizend	qiān
萬	万	萬	万	tienduizend	wàn
億	亿	億	亿	honderdmiljoen	yì

1	yi	一
2	er	二
3	san	三
4	si	四
5	wu	五
6	liu	六
7	qi	七
8	ba	八
9	jiu	九
10	shi	十

## BRAHMI CIJFERS

1	2	3	4	5	6	7	8	9
𑀓	𑀔	𑀕	𑀖	𑀗	𑀘	𑀙	𑀚	𑀛

## NAGARI CIJFERS

1	2	3	4	5	6	7	8	9	0
१	२	३	४	५	६	७	८	९	०
Nagari numerals around 11th century A.D.									

## GRIEKSE CIJFERS

Letter	Waarde	Letter	Waarde	Letter	Waarde
α'	1	ι'	10	ρ'	100
β'	2	κ'	20	σ'	200
γ'	3	λ'	30	τ'	300
δ'	4	μ'	40	υ'	400
ε'	5	ν'	50	φ'	500
Ϝ' of Ϛ' of Ϟ'	6	ξ'	60	χ'	600
ζ'	7	ο'	70	ψ'	700
η'	8	π'	80	ω'	800
θ'	9	ι'	90	ϑ'	900

## BABYLONISCHE CIJFERS

























1	𐎠	11	𐎠𐎠	21	𐎠𐎠𐎠	31	𐎠𐎠𐎠𐎠	41	𐎠𐎠𐎠𐎠𐎠	51	𐎠𐎠𐎠𐎠𐎠𐎠
2	𐎡	12	𐎠𐎡	22	𐎠𐎡𐎡	32	𐎠𐎡𐎡𐎡	42	𐎠𐎡𐎡𐎡𐎡	52	𐎠𐎡𐎡𐎡𐎡𐎡
3	𐎢	13	𐎠𐎢	23	𐎠𐎢𐎢	33	𐎠𐎢𐎢𐎢	43	𐎠𐎢𐎢𐎢𐎢	53	𐎠𐎢𐎢𐎢𐎢𐎢
4	𐎣	14	𐎠𐎣	24	𐎠𐎣𐎣	34	𐎠𐎣𐎣𐎣	44	𐎠𐎣𐎣𐎣𐎣	54	𐎠𐎣𐎣𐎣𐎣𐎣
5	𐎤	15	𐎠𐎤	25	𐎠𐎤𐎤	35	𐎠𐎤𐎤𐎤	45	𐎠𐎤𐎤𐎤𐎤	55	𐎠𐎤𐎤𐎤𐎤𐎤
6	𐎥	16	𐎠𐎥	26	𐎠𐎥𐎥	36	𐎠𐎥𐎥𐎥	46	𐎠𐎥𐎥𐎥𐎥	56	𐎠𐎥𐎥𐎥𐎥𐎥
7	𐎦	17	𐎠𐎦	27	𐎠𐎦𐎦	37	𐎠𐎦𐎦𐎦	47	𐎠𐎦𐎦𐎦𐎦	57	𐎠𐎦𐎦𐎦𐎦𐎦
8	𐎧	18	𐎠𐎧	28	𐎠𐎧𐎧	38	𐎠𐎧𐎧𐎧	48	𐎠𐎧𐎧𐎧𐎧	58	𐎠𐎧𐎧𐎧𐎧𐎧
9	𐎨	19	𐎠𐎨	29	𐎠𐎨𐎨	39	𐎠𐎨𐎨𐎨	49	𐎠𐎨𐎨𐎨𐎨	59	𐎠𐎨𐎨𐎨𐎨𐎨
10	𐎩	20	𐎩𐎩	30	𐎩𐎩𐎩	40	𐎩𐎩𐎩𐎩	50	𐎩𐎩𐎩𐎩𐎩		































## JAPANSE CIJFERS











Nummer	Karakter	Normale uitspraak	On uitspraak	Kun uitspraak
0	零 / 〇	zero	rei / れい	zero / ぜろ
1	一	ichi	ichi / いち	hito(tsu) / ひと・つ
2	二	ni	ni, ji / に, じ	futa(tsu) / ふた・つ
3	三	san	san / さん	mi(ttsu) / み・っつ
4	四	yon	shi / し	yon, yo(ttsu) / よん, よ・っつ
5	五	go	go / ご	itsu(tsu) / いつ・つ
6	六	roku	roku / ろく	mu(ttsu) / む・っつ
7	七	nana	shichi / しち	nana(tsu) / なな・つ
8	八	hachi	hachi / はち	ya(ttsu) / や・っつ
9	九	kyū	kyū, ku / きゅう, く	kokono(tsu) / このの・つ
10	十	jū	jū / じゅう	tō / とお
20	二十	ni-jū	ni-jū / にじゅう	hata(chi) / はた・ち
30	三十	san-jū	san-jū / さんじゅう	miso / みそ
100	百	hyaku	hyaku / ひゃく	(momo / もも)
1.000	千	sen	sen / せん	(chi / ち)
10.000	万	man	man / まん	(yorozu / よろず)
100.000.000	億	oku	oku / おく	-
1.000.000.000.000	兆	chō	chō / ちょう	-
10.000.000.000.000.000	京	kei	kei / けい	-









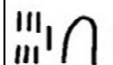
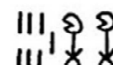



## HIEROGLIEFEN ALFABET

• A 	• B 	• C 	• D 	• E 
• G 	• H 	• I 	• J 	• K 
• L 	• M 	• N 	• O 	• P 
• Q 	• R 	• S 	• T 	• U 
• V 	• W 	• X 	• Y 	• Z 

 A	 A	 B	 C	 D	 E
 F	 G	 H	 H	 I	 J
 K	 L	 M	 N	 N	 O
 P	 Q	 R	 S	 T	 T
 U	 V	 W	 X	 Y	 Z

						
1	10	100	1000	10000	100000	1000000
						
1/2	1/3	2/3	3/4			
	17		2007			

## HIEROGLIEFEN CIJFERS

	1		10		100		1000
	10,000		100,000		1,000,000		
	= 6		= 7		= 8		= 9

## HIEROGLYPHIC TYPEWRITER

<http://discoveringegypt.com/egyptian-hieroglyphic-writing/hieroglyphic-typewriter/>

# BRILLE

**Letters en cijfers** [\[bewerken\]](#)

A of 1	B of 2	C of 3	D of 4	E of 5	F of 6	G of 7	H of 8	I of 9
J of 0	K	L	M	N	O	P	Q	R
S	T	U	V	W	X	Y	Z	

hoofdletter volgt	cijfer volgt	apostrof	punt	komma	puntkomma	uitroepeteken	aanhalingsteken openen <sup>[1]</sup>
aanhalingsteken sluiten	vraagteken <sup>[1]</sup>	haakje <sup>[2]</sup>	afbreektteken (streepje)				

# SOLRESOL

do re mi fa sol la si

1 (do), 2 (re), 3 (mi), 4 (fa), 5 (sol), 6 (la), 7 (si)

do re mi fa sol la si

## VERTICAAL SCHRIFT

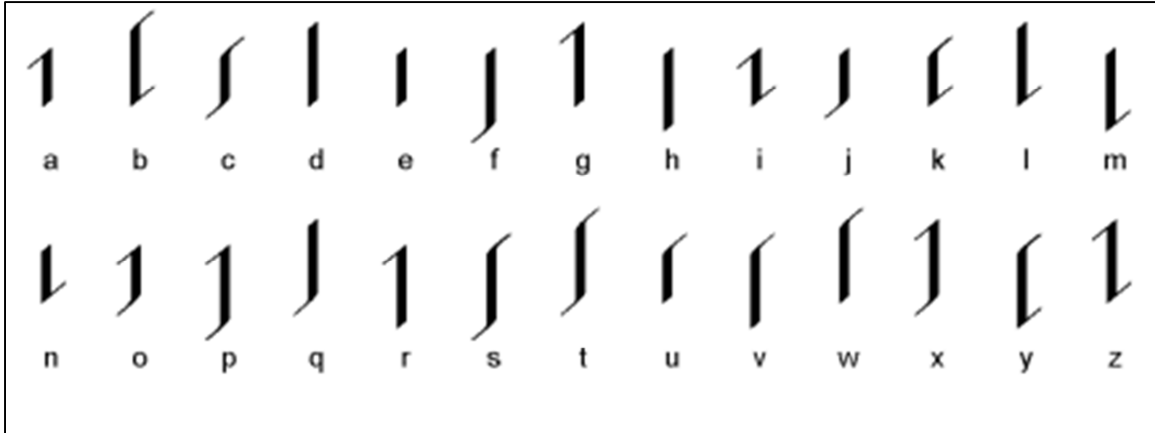

## VERTICAL E GETALLEN

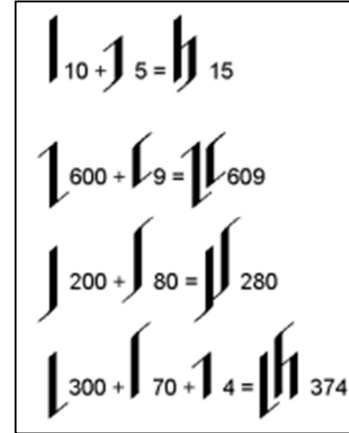

## VERTICAAL CIJFERS

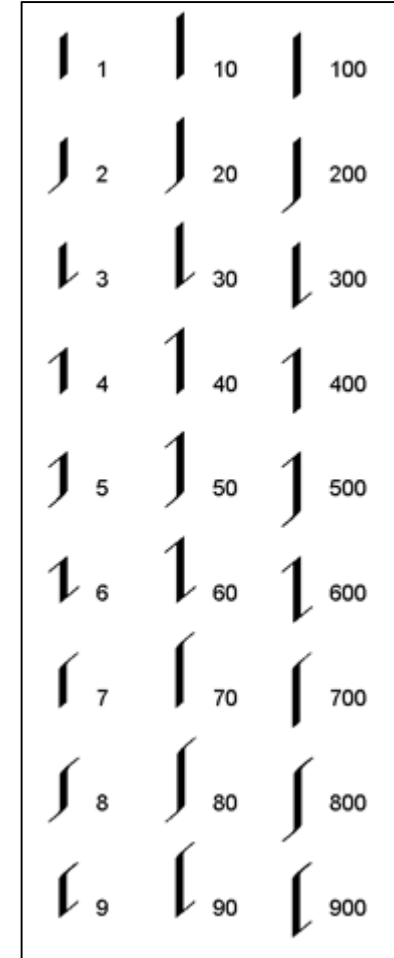

## HET PERIODIEKSYSTEEM

	IA	IIA	IIIB	IVB	VB	VIB	VIIIB	VIIIB	IB	IIB	IIIA	IVA	VA	VIA	VIIA	VIIIA		
1	1 H 1,008															2 He 4,003		
2	3 Li 6,939	4 Be 9,012									5 B 10,811	6 C 12,011	7 N 14,007	8 O 15,999	9 F 18,998	10 Ne 20,183		
3	11 Na 22,990	12 Mg 24,312									13 Al 26,982	14 Si 28,086	15 P 30,974	16 S 32,064	17 Cl 35,453	18 Ar 39,948		
4	19 K 39,102	20 Ca 40,08	21 Sc 44,956	22 Ti 47,88	23 V 50,942	24 Cr 51,996	25 Mn 54,938	26 Fe 55,847	27 Co 58,933	28 Ni 58,69	29 Cu 63,54	30 Zn 65,37	31 Ga 69,72	32 Ge 72,59	33 As 74,922	34 Se 78,96	35 Br 79,909	36 Kr 83,80
5	37 Rb 85,47	38 Sr 87,62	39 Y 88,905	40 Zr 91,22	41 Nb 92,906	42 Mo 95,94	43 Tc (99)	44 Ru 101,07	45 Rh 102,91	46 Pd 106,42	47 Ag 107,87	48 Cd 112,40	49 In 114,82	50 Sn 118,69	51 Sb 121,75	52 Te 127,60	53 I 126,90	54 Xe 131,30
6	55 Cs 132,91	56 Ba 137,34	57 La 138,91	72 Hf 178,49	73 Ta 180,95	74 W 183,85	75 Re 186,2	76 Os 190,2	77 Ir 192,2	78 Pt 195,09	79 Au 196,97	80 Hg 204,59	81 Tl 204,38	82 Pb 209,17	83 Bi 208,98	84 Po (210)	85 At (210)	86 Rn (222)
7	87 Fr (223)	88 Ra (226)	89 Ac (227)															
„6“				58 Ce 140,12	59 Pr 140,91	60 Nd 144,24	61 Pm (145)	62 Sm 150,36	63 Eu 151,96	64 Gd 157,25	65 Tb 158,92	66 Dy 162,50	67 Ho 164,93	68 Er 167,26	69 Tm 168,93	70 Yb 173,04	71 Lu 174,97	
„7“				90 Th 232,04	91 Pa (231)	92 U 238,03	93 Np (237)	94 Pu (242)	95 Am (243)	96 Cm (247)	97 Bk (249)	98 Cf (251)	99 Es (254)	100 Fm (253)	101 Md (256)	102 No (253)	103 Lr (257)	

## ROT 13



# PUZZELCODE

**Alphabet**

**Punctuation**

**Numbers**

# SEGMENTEN VOOR CIJFERS

# OGHAM ALPHABET

A	+	M	/	H	┌	B	┐	EA	✖
O	≡	G	≡	D	≡	L	≡	OI	◇
U	≡	NG	≡	T	≡	F	≡	UI	∩
E	≡	Z	≡	C	≡	S	≡	IA	✖
I	≡	R	≡	Q	≡	N	≡	AE	≡
Start	Y	Space	—	Ende	Y				

	!	#	2	2		0	1	2	3	4	5		x	16		6	7	8	9	a		#	2	2		b	c	d	e	f	
	1	2	8	+		-	τ	π	π	π	π		x	8	?		┌	┐	≡	≡	≡		1	3	9		+	#	#	#	#
	1	4	4	+		+	+	+	+	+	+	+	+	*		x	9	?		◇	◇	✖	≡	—		1	5	5		>	<
	!	#	*	+		0	1	2	3	4	5		x	*	?		6	7	8	9	a		+	1	1		0	1	2	3	4

# QUADOO ALPHABET

↗	↘	↙	↘	┐	┌	1	2	3	4	5	6
A	B	C	D	E	F	7	8	9	0	+	-
↖		/	└	↙	┌	·	!	?	*	#	€
G	H	I	J	K	L	;	:	/			
↗	↖	□	↘	↘	↖						
M	N	O	P	Q	R						
↘	└	┐	↖	↘	✖						
S	T	U	V	W	X						
↖	↘	↗	□	┐	↘						
Y	Z	Ä	Ö	Ü	ß						

## AMINOZUREN CODE-ZON

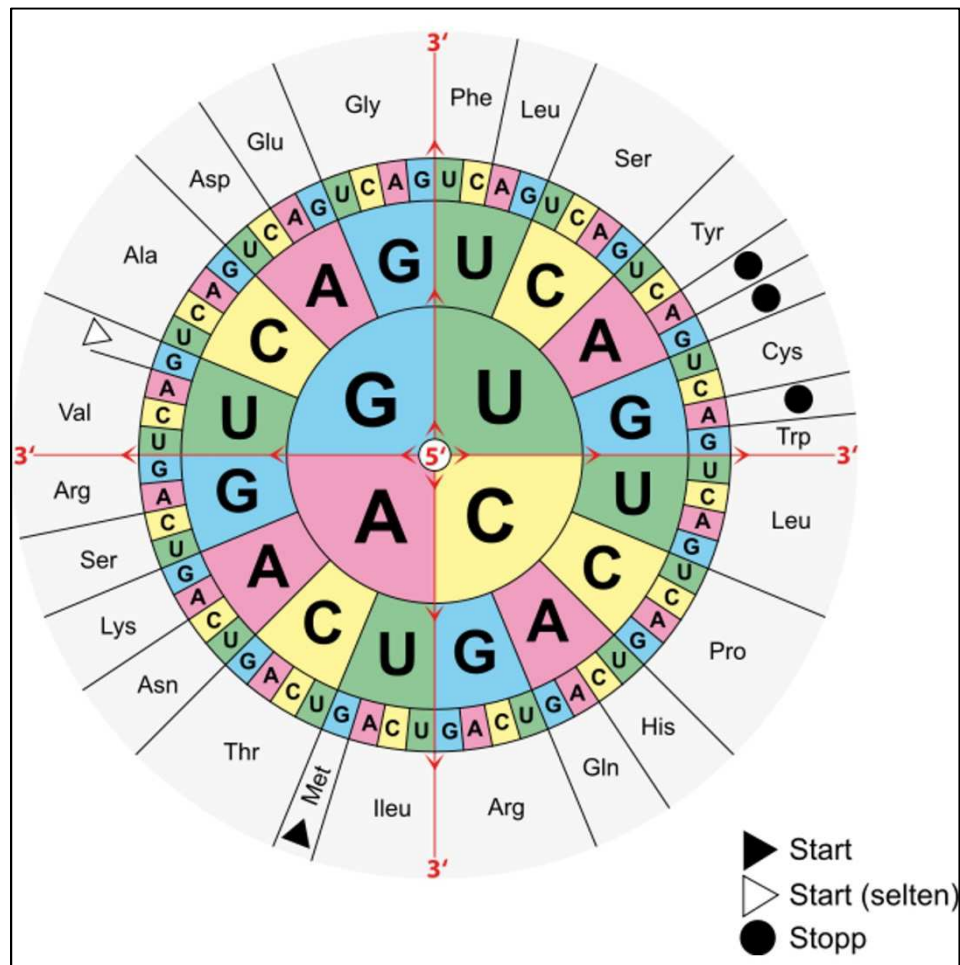

## UTOPIA

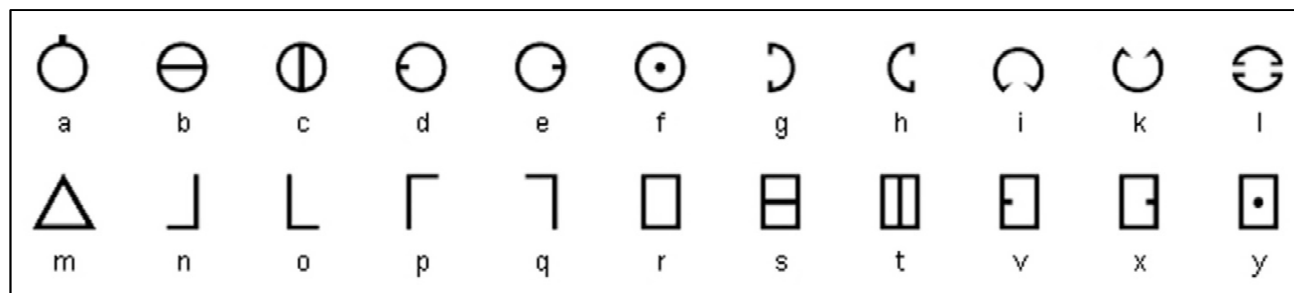

## CHEROKEE ALPHABET

a	e	i	o	u	v [ə]
D a	R e	T i	Ꭰ o	Ꭱ u	i v
Ꭲ ga Ꭳ ka	Ꭴ ge	Ꭵ gi	A go	J gu	E gv
Ꭶ ha	Ꭷ he	Ꭸ hi	F ho	Ꭹ hu	Ꭺ hv
W la	Ꭾ le	Ꭿ li	G lo	M lu	Ꮀ lv
Ꮃ ma	Ꮂ me	H mi	Ꮄ mo	Ꮅ mu	
Ꮎ na Ꮏ hna Ꮐ nah	Ꮊ ne	Ꮋ ni	Z no	Ꮌ nu	Ꮍ nv
Ꮑ qua	Ꮒ que	Ꮓ qui	Ꮔ quo	Ꮕ quu	Ꮖ quv
Ꮗ s Ꮘ sa	Ꮙ se	Ꮚ si	Ꮛ so	Ꮜ su	R sv
Ꮝ da Ꮞ ta	Ꮟ de Ꮠ te	Ꮡ di Ꮢ ti	Ꮣ do	Ꮤ du	Ꮥ dv
Ꮦ dla Ꮧ tla	L tle	C tli	Ꮮ tlo	Ꮯ tlu	P tlv
G tsa	Ꮮ tse	Ꮯ tsi	K tso	Ꮰ tsu	Ꮱ tsv
G wa	Ꮮ we	Ꮮ wi	Ꮮ wo	Ꮮ wu	Ꮮ wv
Ꮮ ya	Ꮮ ye	Ꮮ yi	Ꮮ yo	G yu	B yv

## GRIEKS ALFABET

A α	alpha	N ν	nu
B β	beta	Ξ ξ	xi
Γ γ	gamma	Ο ο	omikron
Δ δ	delta	Π π	pi
E ε	epsilon	Ρ ρ	rho
Z ζ	zeta	Σ σ	sigma
H η	eta	Τ τ	tau
Θ θ	theta	Υ υ	upsilon
I ι	iota	Φ φ	phi
K κ	kappa	Χ χ	chi
Λ λ	lambda	Ψ ψ	psi
M μ	mu	Ω ω	omega

## PRIEMGETALLEN

2	3	5	7	11	13	17	19	23	29	31	37
41	43	47	53	59	61	67	71	73	79	83	
89	97	101	103	107	109	113	127	131	137		
139	149	151	157	163	167	173	179	181			
191	193	197	199	211	223	227	229	233			
239	241	251	257	263	269	271	277	281			
283	293	307	311	313	317	331	337	347			
349	353	359	367	373	379	383	389	397			
401	409	419	421	431	433	439	443	449			
457	461	463	467	479	487	491	499	503			
509	521	523	541	547	557	563	569	571			
577	587	593	599	601	607	613	617	619			
631	641	643	647	653	659	661	673	677			
683	691	701	709	719	727	733	739	743			
751	757	761	769	773	787	797	809	811			
821	823	827	829	839	853	857	859	863			
877	881	883	887	907	911	919	929	937			
941	947	953	967	971	977	983	991	997	(168		

## TRANSISTOR KLEURENCODE

N	N	x (pF)	Tol	VDC
0	0	1	20%	-
1	1	10	-	100
2	2	100	-	250
3	3	1k	-	-
4	4	10k	-	400
5	5	100k	-	-
6	6	-	-	630
7	7	-	-	-
8	8	0,01	-	-
9	9	0,1	10%	-

## FENECIERS ALFABET

⤵	alef	⊃	ℓ	lamed	l
⤴	bet	b	Ⓜ	mem	m
^	gimel	g	Ⓝ	nun	n
△	dalet	d	⌘	samech	s
⊚	he	h	⊙	ajin	⊖
Υ	waw	w	Ⓟ	pe	p
⊥	sajin	z	Ⓢ	sade	s
⊞	chet	ch	⊘	kof	q
⊗	tet	t	Ⓜ	resch	r
Ⓝ	jod	j	Ⓜ	schin	sc
Ⓝ	kaf	k	Ⓜ	taw	t

## ALPHABET OF MARY QUEEN OF SCOTS

a	b	c	d	e	f	g	h	i	j	k	l	m
⊙	⌘	^	⊕	Ⓜ	□	⊖	∞	l		Ⓜ	Ⓝ	//
n	o	p	q	r	s	t	u	v	w	x	y	z
Ⓝ	Ⓜ	Ⓜ	Ⓜ	f	△	ε	⊖			7	8	9

## REKENMACHINE

1	2	3	4	5	6	7	8	9	0
i	z	e	h	s	g	l			o
I	Z	E	H	S		L	B	G	O

## HEXAHUE CODE

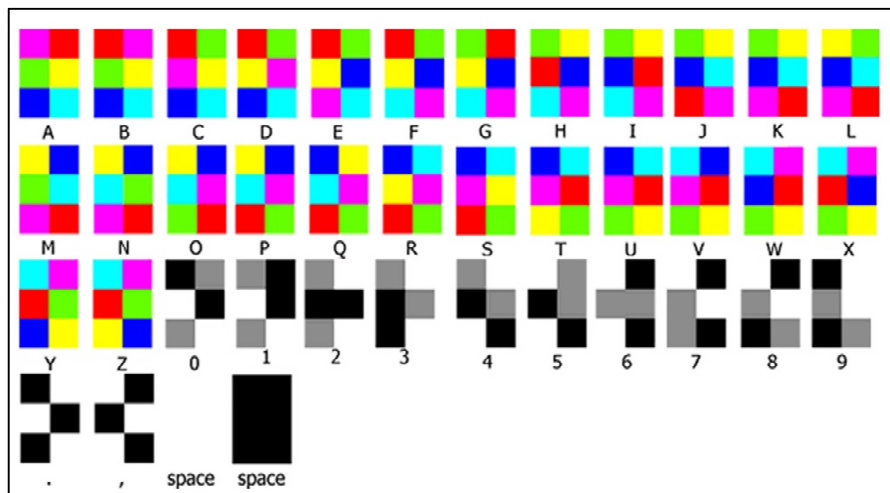

## VERFKLEUREN

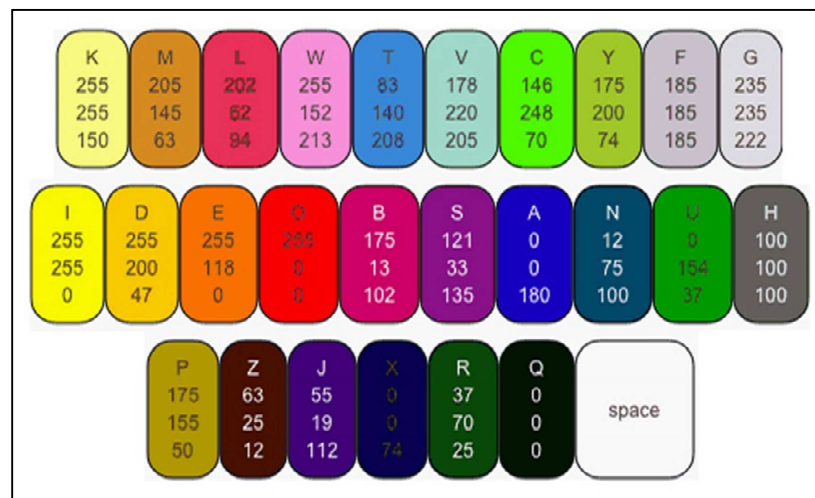

## UNITOLOGY ALPHABET



## BRITSE DIALECTEN GETALLEN

	Cumbria			Yorkshire		
	Millom	Keswick	Kirkby Lonsdale	North Riding	Swaledale	Wensleydale
1	aina	yan	yaan	arn	yahn	yan
2	peina	tyan	tyaan	tarn	tayhn	tean
3	para	tethera	taed'ere	tethera	tether	tither
4	pedera	methera	mead'ere	fethera	methier	mither
5	pump	pimp	mimp	pubs	mimph	pip
6	ithy	sethera	haites	aayther	hither	teaser
7	mithy	lethera	saites	layather	lither	leaser
8	owera	hovera	haoves	quoaather	anver	catra
9	lavera	dovera	daoves	quaaather	danver	horna

# ALCHEMY CODES

	Alcohol		Fumes		Potash
	Alkali		Ginger		Powder
	Alum		Gold Foil		Quicksilver (Mercury)
	Ammonia		Gold Litharge (Lead Monoxide)		Rocksalt
	Aqua		Gold Saffron		Resin
	Red Arsenic (Resigar)		Gold Trunkbar (N.B. A drink containing gold)		Salt
	White Arsenic (Arsenic Tetroxide)		Gravel		Saltpeter
	Arsenic Sulfur		Haematite (Hematite)		Sea Salt
	Yellow Arsenic (Oxymuri)		Honey		Silicon (Modern alchemy only)
	Beeswax		Iron Filings		Silver Spirit
	Bronze		Iron Root		Skull
	Brass		Iron Vitriol (Sulfate)		Soapstone
	Breaststone (Sulphur, Sulfur)		Lapis Lazuli		Soot
	Burned Alum		Red Lead (Lead Tetroxide) (Lithpatrik Tetroxide)		Spirit
	Burned Mathon		Lute		Spirit of Mercury
	Calced Gold		Lye		Spirit of Tin
	Chalk		Magnesia		Sugar
	Cinder		Muriac		Tartar (Tartaric acid)
	Clay		Niter Flower		Tarnishing of Silver
	Copper Acetate		Niter Oil		Urine
	Cognac		Nitric Acid (Aqua Fortis)		Verdigris
	Crabbed Ashes		Oil (Oleum)		Vinegar
	Crystal		Oil Essence		Vitriol
	Distilled Vinegar		Oil of Vitriol (Sulphuric Acid)		Wax
	Eggshells		Potter		Wood

# ALCHEMY ELEMENTS

	Aluminum
	Cobalt
	Copper
	Iron
	Lead
	Mercury
	Nickel
	Silver
	Steel
	Tin
	Antimony
	Arsenic
	Bismuth
	Boron
	Magnesium
	Phosphorus
	Platinum
	Potassium
	Stone
	Sulphur (Sulfur)
	Zinc







PIGPEN CIPHER  
FREEMASON'S CIPHER  
PIGPEN CIPHER VARIATION  
MASONIC CIPHER  
(VARIATION FROM ASSASSINS CREED II)  
FREEMASON'S CIPHER  
ROSICRUCIAN CIPHER  
TIC-TAC-TOE CIPHER  
TEMPLARS CIPHER  
HTLM KLEURCODES  
PYRAMID CIPHER  
COLORHONEY ALPHABET  
COLORTOKKI ALPHABET  
SEMAPHORE ALPHABET  
VLAGGENSEINEN  
MARITIEME SEINVLAGGEN  
TELEFOON ALFABET  
SHUTTERS TELEGRAPH CODE  
CHAPPE CODE  
REUSSER'S TELEGRAPH ALFABET  
MORSE ALFABET  
MNEMOMIC  
CCITT  
ASHLEY ALPHABET  
BINAIRE GETALLEN  
VANITY (OF SMS) CODE  
DTMF TOON CODE/VANITYCODE

STIPPELCODE ALFABET  
KIX-CODE  
CODE 39  
PREUSSISCHE TELEGRAPHALFABET  
BLOX  
VINGERALFABET  
ALBERTI CIPHER  
NAVAJO CIJFER  
MAYA CIJFERS  
ARABISCHE CIJFERS  
HINDI CIJFERS  
CHINESE CIJFERS  
TAMIL CIJFERS  
CYRILISCHE CIJFERS  
ROMEINSE CIJFERS  
BRAHMI CIJFERS  
NAGARI CIJFERS  
GRIEKSE CIJFERS  
JAPANSE CIJFERS  
BABYLONISCHE CIJFERS  
HIEROGLIEFEN  
BRAILLE  
SOLRESOL  
VERTICAAL SCHRIFT  
HET PERIODIEK SYSTEEM  
ROT 13  
PUZZELCODE

OGHAM ALPHABET  
SEGMENTEN VOOR CIJFERS  
QUADOO ALPHABET  
AMINOZUREN CODE-ZON  
CHEROKEE ALPHABET  
UTOPIA  
GRIEKS ALFABET  
PRIEMGETALLEN  
TRANSISTOR KLEUREN  
FENICIERS ALFABET  
REKENMACHINE  
MARY QUEEN OF SCOTS  
HEXAHUE CODE  
VERFKLEUREN  
UNITOLOGY ALPHABET  
BRITSE DIALECTEN  
ALCHEMY CODES  
D'NI  
WINGDINGS  
WEBDINGS  
SYMBOLS  
MARAIN ALPHABET

# MIJN CODEBOEK 3.1

## deel 2



## BASIC CIPHERS OF THE MONKS

Type	name	1	2	3	4	5	6	7	8	9	use
I	Basingstoke	↘	↘	↘	↘	↘	↘	↘	↘	↘	U   T
IIa	Early Cistercian	└	└	└	└	└	└	└	└	└	T   C K   H
IIb	hypothetical	└	└	└	└	└	└	└	└	└	·   · ·   ·
IIc	Standard Cistercian	└	└	└	└	└	└	└	└	└	T   C K   H ·   · ·   ·
IIId	hypothetical	└	└	└	└	└	└	└	└	└	·   · ·   ·
IIe	hypothetical	└	└	└	└	└	└	└	└	└	·   · ·   ·
IIIf	anomalous	└	└	└	└	└	└	└	└	└	·   · ·   ·
IIg	anomalous Lyons	└	└	└	└	└	└	└	└	└	·   · ·   ·
IIIId	Agrippa	└	└	└	└	└	└	└	└	└	K   T C   H ·   · ·   ·
IIIe	Picard astrolabe	└	└	└	└	└	└	└	└	└	·   · ·   ·
IV	Cardano	└	└	└	└	└	└	└	└	└	·   · ·   ·

## BASINGSTOKE CIPHER

└	└	└	└	└	└	└	└	└	└	1	2	3	4	5	6	7	8	9
└	└	└	└	└	└	└	└	└	└	10	20	30	40	50	60	70	80	90
└	└	└	└	└	└	└	└	└	└	100	200	300	400	500	600	700	800	900
└	└	└	└	└	└	└	└	└	└	1000	2000	3000	4000	5000	6000	7000	8000	9000

with which, for example:

└	└	└	└	└	└	└	└	└	└	1992	4723	6859	7085	8971	9938
---	---	---	---	---	---	---	---	---	---	------	------	------	------	------	------

For native English-speakers (as well as for those counting above 99 in Latin), reading the ciphers involves the following mental gymnastics:

```

    tens      →      units
    ↙
    thousands →      hundreds
  
```

└	└	└	└	└	└	└	└	└	└	1	2	3	4	5	6	7	8	9
└	└	└	└	└	└	└	└	└	└	10	20	30	40	50	60	70	80	90
└	└	└	└	└	└	└	└	└	└	100	200	300	400	500	600	700	800	900
└	└	└	└	└	└	└	└	└	└	1000	2000	3000	4000	5000	6000	7000	8000	9000

604 = └└└    2012 = └└└└    7538 = └└└└    9999 = └└└└

These are the developed Cistercian numerals, which were first written horizontally, and then vertically. They represent integers from 0 to 9999.

## STANDARD CISTERNIAN

1	2	3	4	5	6	7	8	9
10	20	30	40	50	60	70	80	90
100	200	300	400	500	600	700	800	900
1000	2000	3000	4000	5000	6000	7000	8000	9000

and combinations are formed by adding the appropriate appendages, thus:

1323	4567	5781	8956	9239

The arrangement of the appendages for the units (U), tens (T), hundreds (H) and thousands (K) is:

U	H
T	K

## HEIDELBERGER CIPHERS

1	2	3	4	5	6	7	8	9	
a	b	c	d	e	f	g	h	i	
10	11	12	13	14	15	16	17	18	19
k	l	m	n	o	p	q	r	s	t
20	21	22	23						
u	x	y	z						

## CISTERNIAN CIPHERS

1	2	3	4	5	6	7	8	9
10	20	30	40	50	60	70	80	90
100	200	300	400	500	600	700	800	900
1000	2000	3000	4000	5000	6000	7000	8000	9000
1993	4723	6859	7085	9433				

## ATLANTEAN ALPHABET

a	b	c	d	e	f	g	h	i	j	k	l	m
n	o	p	q	r	s	t	u	v	w	x	y	z
ch	sh	th	0	1	2	3	4	5	6	7	8	9

**CIRTH ALPHABET TOLKIEN**

Ɔ	Ɔ	Ɔ	Ɔ	Ɔ	Ɔ	Ɔ	Ɔ	Ɔ	Ɔ	Ɔ	Ɔ	Ɔ
p	b	f	v	hw	m	(mh)/mb	t	d	th	dh	n-r	ch
Ɔ	Ɔ	Ɔ	Ɔ	Ɔ	Ɔ	Ɔ	Ɔ	Ɔ	Ɔ	Ɔ	Ɔ	Ɔ
j	sh	zh	nj-z	k	g	kh	gh	ŋ-n	kw	gw	khw	ghw/w
Ɔ	Ɔ	Ɔ	Ɔ	Ɔ	Ɔ	Ɔ	Ɔ	Ɔ	Ɔ	Ɔ	Ɔ	Ɔ
ngw	nw	r-j	rh-zh	l	lh	ng-nd	s-h	s-'	z-ŋ	ng*	nd-nj	
Ɔ	Ɔ	Ɔ	Ɔ	Ɔ	Ɔ	Ɔ	Ɔ	Ɔ	Ɔ	Ɔ	Ɔ	Ɔ
i/(y)	y*	hy*	u	ü	w	ü	e	ē	a	ā	o	
Ɔ	Ɔ	Ɔ	Ɔ	Ɔ	Ɔ	Ɔ	Ɔ	Ɔ	Ɔ	Ɔ	Ɔ	Ɔ
ō	ö	n*	h-s	*	*	ps*	ts*	+h	&			

**SARATI ALPHABET TOLKIEN**

Ɔ	t	Ɔ	j	Ɔ	dh	Ɔ	ng	Ɔ	st
[t]	[dʒ]	[ð]	[ŋ]	[st]					
Ɔ	p	Ɔ	g	Ɔ	v	Ɔ	r	Ɔ	h
[p]	[g]	[v]	[r]	[h]					
Ɔ	ch	Ɔ	th	Ɔ	zh	Ɔ	l	Ɔ	u
[tʃ]	[θ]	[z]	[l]	[u]					
Ɔ	k	Ɔ	f	Ɔ	gh	Ɔ	s	Ɔ	i
[k]	[f]	[ɣ]	[s]	[i]					
Ɔ	d	Ɔ	sh	Ɔ	n	Ɔ	s	Ɔ	w
[d]	[ʃ]	[n]	[s]	[w]					
Ɔ	b	Ɔ	x	Ɔ	m	Ɔ	z		
[b]	[x]	[m]	[z]						

Ɔ Ɔ Ɔ Ɔ Ɔ Ɔ Ɔ Ɔ

a e i o u æ a

**URUK RUNES ALPHABET TOLKIEN**

<b>A</b>	<b>E</b>	<b>I</b>	<b>O</b>	<b>U</b>															
Ɔ	Ɔ	Ɔ	Ɔ	Ɔ															
<b>B</b>	<b>D</b>	<b>F</b>	<b>G</b>	<b>H</b>	<b>J(y)</b>	<b>K</b>	<b>L</b>	<b>M</b>	<b>N</b>	<b>P</b>	<b>R</b>	<b>S</b>	<b>T</b>	<b>V</b>	<b>W</b>	<b>Z</b>	<b>TH</b>	<b>SH</b>	
Ɔ	Ɔ	Ɔ	Ɔ	Ɔ	Ɔ	Ɔ	Ɔ	Ɔ	Ɔ	Ɔ	Ɔ	Ɔ	Ɔ	Ɔ	Ɔ	Ɔ	Ɔ	Ɔ	Ɔ

**DRAGON RUNES**

eh	uh	oo	g	t
e	o	ou	j	th
a	ah	k	n	L
z	sh	ch	m	v
s	d	p	r	f
b				

# TOLKIENS SCRIPTS

These scripts were invented by J. R. R. Tolkien and appear in his novels *The Hobbit*, *The Lord of the Rings* and *The Silmarillion*. Tolkien's Tengwar script was originally designed to write the Elvish languages Quenya and Sindarin, but has been adapted to write quite a few other languages.

YHNK7N>·FNHKA Y

[Cirth](#)

[Sarati](#)

FNDRK NRK

[Uruk Runes](#)

[Tengwar for Quenya and Sindarin](#)

[Tengwar for English](#)

[Tengwar for Hungarian](#)

[Tengwar for Latin American Spanish](#)

[Tengwar for Scottish Gaelic \(Version 1\)](#)

[Tengwar for Scottish Gaelic \(Version 2\)](#)

[Tengwar for Spanish](#)

[Tengwar for Welsh](#)

## ATH ALPHABET

Z	U	O	N	C	I	S	T	E	H	A	E	O	
a	i	u	é	o	e	c	s	t	l	n	h	p	f
[a]	[i]	[u]	[e]	[o]	[ə]	[k]	[s]	[t]	[l]	[n]	[h]	[p]	[f]
d	ū	P	Ń	Ń	Y	Ń	Ń	Ń	Ń	Ń	Ń	Ń	Ń
m	ī	ai	y	œ	r	ū	au	ŷ	eu	g	z	d	b
[m]	[i]	[ɛ]	[y]	[œ]	[r]	[w]	[o]	[ɥ]	[ø]	[g]	[z]	[d]	[b]

## ARCADIAN ALPHABET

⊙	⊙	⊙	⊙	⊙	⊙	⊙	⊙	⊙	⊙	⊙	⊙	⊙	⊙
a	b	c	d	e	f	g	h	i	j	k	l	m	
⊙	⊙	⊙	⊙	⊙	⊙	⊙	⊙	⊙	⊙	⊙	⊙	⊙	⊙
n	o	p	q	r	s	t	u	v	w	x	y	z	

⊙	⊙	⊙	⊙	⊙	⊙	⊙	⊙	⊙	⊙
0	1	2	3	4	5	6	7	8	9



## ANCIENT ALPHABET

a	b	c	d	e	f	g	h	i	j	k	l	m
n	o	p	q	r	s	t	u	v	w	x	y	z
Numerals												
0	1	2	3	4	5	6	7	8	9			

## AUREK-BESK ALPHABET

aurek	besh	cresh	dora	esk	forn	grek	herf	isk	jenth	krill	leth
a	b	c	d	e	f	g	h	i	j	k	l
mem	nem	osk	peth	qek	resh	senh	trill	usk	vev	wesk	
m	n	o	p	q	r	s	t	u	v	w	
xesh	yirt	zerek	cherk	enth	onith	krenth	nen	orenth	shen	thes	
x	y	z	ch	ae	eo	kh	ng	oo	sh	th	
,	.	?	!	:	;	-	"	'	(	)	/
0	1	2	3	4	5	6	7	8	9		

## OLD HYLIAN SYLLABARY

a	i	u	e	o	ka	ki	ku	ke	ko
sa	shi	su	se	so	ta	chi	tsu	te	to
na	ni	nu	ne	no	ha	hi	fu	he	ho
ma	mi	mu	me	mo	ra	ri	ru	re	ro
ya	yu	yo	wa	n	wo				

## FONIC ALPHABET

a	b/v	c	d	e	f	g/j	h		
i	k	l	m	n	o	p	q		
r	s	t	u	w	y	z			
Numerals									
0	1	2	3	4	5	6	7	8	9



SKY ALPHABET / DRACHENSPRACHE /SKYRIM

0	1	2	3	4	5	6	7	8	9	*
A	B	C	D	E	F	G	H	I		
J	K	L	M	N	O	P	Q	R		
S	T	U	V	W	X	Y	Z			
aa	ah	ei	ii	oo	ir	uu	ur	ey		
a	h	e	i	o	r	u	w	y		

SKYRIM'S DRAGON ALPHABET

A	B	C	D	E	F	G	H	I	J	K	L	M
N	O	P	Q	R	S	T	U	V	W	X	Y	Z
1	2	3	4	5	6	7	8	9				

SKYRIM DRAGON CIJFERS (2)

(1)	(2)	(3)	(4)	(4)	(5)
(6)	(7)	(8)	(9)	(10)	(0)

HEAIAIAANS

A	F	K	P	u	Y
B	G	L	Q	v	? ψ
C	H	M	R	w	Ξ Ξ
D	I	N	S	X	
E	J	O	T	Y	

ANCIENT BRANDOBIAN

A	B	C	D	E	F	G	H	I	L	LD	LN
M	N	ND	O	P	R	S	T	U			
V	VL	VR	W	Y	Z						

## ELVISH ALPHABET

A		J		S		
B		K		T		
C		L		U		
D		M		V		
E		N		W		
F		O		X		
G		P		Y		
H		Qu		Z		
I		R				

## DOTHRAKI (GAME OF THRONES)

a	b	ch	d	e	f	g	h	i	j
[a]	[b]	[tʃ]	[d]	[e]	[f]	[g]	[h]	[i]	[dʒ]
k	kh	l	m	n	o	p	q	r	s
[k]	[x]	[l]	[m]	[n]	[o]	[p]	[q]	[r]	[s]
sh	t	th	v	w	y	z	zh		
[ʃ]	[t]	[θ]	[v]	[w]	[j]	[z]	[ʒ]		

DWEMER AYLEID FALMER

	A	B	C	D	E	F	G	H	I	J	K	L	M	N	O	P	Q	R	S	T	U	V	W	X	Y	Z
Letter Name	AHH	BTH	LCH	ND	EH	FT	NGTH	AH	IH	JT	RK	LFT	MZ	NCH	OW	PTH	KWH	RD	SH	RT	UH	VTH	HWH	AWE	OY	ST
Number	1	2	3	4	5	6	7	8	9	10																
Dwemer (Runes)	𐌰	𐌱	𐌲	𐌳	𐌴	𐌵	𐌶	𐌷	𐌸	𐌹	𐌺	𐌻	𐌼	𐌽	𐌾	𐌿	𐍀	𐍁	𐍂	𐍃	𐍄	𐍅	𐍆	𐍇	𐍈	𐍉
Dwemer (Script)	𐌰			𐌳	𐌴	𐌵	𐌶	𐌷	𐌸			𐌻	𐌼	𐌽				𐍁	𐍂			𐍄	𐍅		𐍈	𐍉
Dwemer (Skyrim)	𐌰	𐌱	𐌲	𐌳	𐌴	𐌵	𐌶	𐌷	𐌸	𐌹	𐌺	𐌻	𐌼	𐌽	𐌾	𐌿	𐍀	𐍁	𐍂	𐍃	𐍄	𐍅	𐍆	𐍇	𐍈	𐍉
Ayleid	𐌰	𐌱	𐌲	𐌳	𐌴		𐌶	𐌷	𐌸			𐌻	𐌼	𐌽				𐍁	𐍂	𐍃	𐍄	𐍅			𐍈	𐍉
Falmer	𐌰	𐌱	𐌲	𐌳	𐌴	𐌵	𐌶	𐌷	𐌸	𐌹	𐌺	𐌻	𐌼	𐌽	𐌾	𐌿	𐍀	𐍁	𐍂	𐍃	𐍄	𐍅	𐍆	𐍇	𐍈	𐍉
Falmer (Simple)	𐌰	𐌱	𐌲	𐌳	𐌴	𐌵	𐌶	𐌷	𐌸	𐌹	𐌺	𐌻	𐌼	𐌽	𐌾	𐌿	𐍀	𐍁	𐍂	𐍃	𐍄	𐍅	𐍆	𐍇	𐍈	𐍉

RUNES ALPHABET 1889

a	á	α	u	b	β	c	d	đ	e	f	g	g
𐌰	𐌱	𐌲	𐌳	𐌴	𐌵	𐌶	𐌷	𐌸	𐌹	𐌺	𐌻	𐌼
g	h	h	h	i	k	l	m	n	o	o	o	o
𐌽	𐌾	𐌿	𐍀	𐍁	𐍂	𐍃	𐍄	𐍅	𐍆	𐍇	𐍈	𐍉
o	p	q	q	r	s	s	t	t	u	x	z	
𐍀	𐍁	𐍂	𐍃	𐍄	𐍅	𐍆	𐍇	𐍈	𐍉	𐍊	𐍋	𐍌

RUNES

†	‡	Λ	⊠	Σ	×	†	‡	↑	×	∩	∩	
i	h	gy	g	f	é	e	d	cs	c	b	á	a
⊠	⊠	∩	∩	∩	∩	∩	∩	∩	∩	∩	∩	∩
ő	ö	ó	o	ny	n	m	ly	l	k	k	j	í
Y	‡	M	⊠	∩	∩	∩	∩	∩	∩	∩	∩	∩
zs	z	v	ú	ü	ú	u	ty	tsz	s	r	p	

### RUNE ALPHABET

ᚦ	ᚢ	ᚠ	ᚡ	ᚥ	ᚱ	ᚷ	ᚨ	ᚱ	ᚹ	
A	B	C	D	E	F	G	H	I	J	
ᚫ	ᚬ	ᚱ	ᚮ	ᚱ	ᚢ	ᚷ	ᚨ	ᚱ	ᚮ	ᚹ
K	L	M	N	O	P	R	S	T	U	V
ᚱ	ᚮ	ᚱ	ᚱ							
W	X	Y	Z							

### KLASSISCH RUNEN

A	B	C	D	E	F	G	H	I	J
ᚱ	ᚷ	ᚱ	ᚷ	ᚱ	ᚱ	ᚱ	ᚱ	ᚱ	ᚱ
K	L	M	N	O	P	Q	R	S	T
ᚱ	ᚱ	ᚷ	ᚱ	ᚱ	ᚱ	ᚱ	ᚱ	ᚱ	ᚱ
U	V	W	X	Y	Z				
ᚱ	ᚱ	ᚱ	ᚱ	ᚱ	ᚱ				



### MONDRUNEN

A	B	C	D	E	F	G	H	I	J
ᚱ	ᚷ	ᚱ	ᚱ	ᚱ	ᚱ	ᚱ	ᚱ	ᚱ	ᚱ
K	L	M	N	O	P	Q	R	S	T
ᚱ	ᚱ	ᚱ	ᚱ	ᚱ	ᚱ	ᚱ	ᚱ	ᚱ	ᚱ
U	V	W	X	Y	Z				
ᚱ	ᚱ	ᚱ	ᚱ	ᚱ	ᚱ				



### RUNIC

A	B	C	D	E	F	G	H	I	J
ᚱ	ᚷ	ᚱ	ᚱ	ᚱ	ᚱ	ᚱ	ᚱ	ᚱ	ᚱ
K	L	M	N	O	P	Q	R	S	T
ᚱ	ᚱ	ᚱ	ᚱ	ᚱ	ᚱ		ᚱ	ᚱ	ᚱ
U	V	W	X	Y	Z				
ᚱ	ᚱ			ᚱ	ᚱ				



### ROVAS-SVABVANY RUNEN

A	B	C	D	E	F	G	H	I	J
𐌰	𐌱	𐌲	𐌳	𐌴	𐌵	𐌶	𐌷	𐌸	𐌹
K	L	M	N	O	P	Q	R	S	T
𐌺	𐌻	𐌼	𐌽	𐌾	𐌿	𐍀	𐍁	𐍂	𐍃
U	V	W	X	Y	Z				
𐍄	𐍅	𐍆	𐍇	𐍈	𐍉				

### FUTHARKEN

A	B	C	D	E	F	G	H	I	J
𐌰	𐌱	𐌲	𐌳	𐌴	𐌵	𐌶	𐌷	𐌸	𐌹
K	L	M	N	O	P	Q	R	S	T
𐌺	𐌻	𐌼	𐌽	𐌾	𐌿	𐍀	𐍁	𐍂	𐍃
U	V	W	X	Y	Z				
𐍄	𐍅	𐍆	𐍇	𐍈	𐍉				

### GERMANISCHE RUNEN

A	B	C	D	E	F	G	H	I	J
𐌰	𐌱		𐌳	𐌴	𐌵	𐌶	𐌷	𐌸	𐌹
K	L	M	N	O	P	Q	R	S	T
𐌺	𐌻	𐌼	𐌽	𐌾	𐌿		𐍁	𐍂	𐍃
U	V	W	X	Y	Z				
𐍄	𐍅	𐍆			𐍉				

### FUTHARK

A	B	C	D	E	F	G	H	I	J
𐌰	𐌱	𐌲	𐌳	𐌴	𐌵	𐌶	𐌷	𐌸	𐌹
K	L	M	N	O	P	Q	R	S	T
𐌺	𐌻	𐌼	𐌽	𐌾	𐌿		𐍁	𐍂	𐍃
U	V	W	X	Y	Z				
𐍄		𐍆		𐍈	𐍉				







## FUTURAMA ALIEN ALPHABET

Letters												
a	b	c	d	e	f	g	h	i	j	k	l	m
n	o	p	q	r	s	t	u	v	w	x	y	z
Numerals												
0	1	2	3	4	5	6	7	8	9			
Punctuation												
;	:	.	-	'	!							

## ROMULAN ALPHABET

A	B	C	D	E	F	G	H	I	J	K	L	M
a	b	c	d	e	f	g	h	i	j	k	l	m
N	O	P	Q	R	S	T	U	V	W	X	Y	Z
n	o	p	q	r	s	t	u	v	w	x	y	z
0	1	2	3	4	5	6	7	8	9			

## KLINGON ALPHABET

a	b	ch	D	e	gh	H	I	j	l	m	n	ng
[a]	[b]	[tʃ]	[d]	[e]	[y]	[x]	[ɾ]	[dʒ]	[l]	[m]	[n]	[ŋ]
o	p	q	Q	r	S	t	th	u	v	w	y	'
[o]	[p <sup>h</sup> -pf]	[q <sup>h</sup> ]	[qʷ]	[r]	[s]	[t <sup>h</sup> ]	[tʰ]	[u]	[v]	[w]	[j]	[ʔ]
0	1	2	3	4	5	6	7	8	9			

## STANDARD GALACTIC ALPHABET

a	b	c	d	e	f	g	h	i	j	k	l	m	n
o	p	q	r	s	t	u	v	w	x	y	z		

### VISITORS ALPHABET (VERSION 2009)

A	Ã	AR	B	C	CH	D	E	Ê	ES	F	G
GH	H	I	Î	IA	J	K	L	LL	M	N	O
Ô	P	Q	R	RR	S	SS	SH	T	TH	U	Û
						V symbol					
V	W	X	Y	Z	V symbol	V symbol					
0	1	2	3	4	5	6	7	8	9		

### VISITORS ALPHABET (VERSION 1984)

A	B	C	D	E	F	G	H	I	J	K	L
M	N	O	P	Q	R	S	T	U	V	W	

### CYBERTRONIAN

A	B	C	D	E	F	G	H	I	J	K	L	M	N	O
P	Q	R	S	T	U	V	W	X	Y	Z				
1	2	3	4	5	6	7	8	9	0					

### ZODIAK

	Westers:	Chinees:
1	(ram)	鼠 (rat)
2	(stier)	牛 (os)
3	(tweelingen)	虎 (tijger)
11	(kreeft)	兔 (konijn)
12	(leeuw)	龍 (draak)
13	(maagd)	蛇 (slang)
21	(weegschaal)	馬 (paard)
22	(schorpioen)	羊 (geit)
23	(boogschutter)	猴 (aap)
31	(steenbok)	雞 (haan)
32	(waterman)	狗 (hond)
33	(vissen)	豬 (varken)

### KRYPTONIAN ALPHABET

a	b	c	d	e	f	g	h	i	j	k	l	m
n	o	p	q	r	s	t	u	v	w	x	y	z



ENCHANTMENT TABLE CODE/STANDARD GALACTIC ALPHABET

⤴	⤵	∩	⤴	⤵	⤴	⤵	∩	∩	+	∩	∩
A	B	C	D	E	F	G	H	I	J	K	L
∩	∩	∩	∩	∩	∩	∩	∩	∩	∩	∩	∩
N	O	P	Q	R	S	T	U	V	W	X	Y

end sentence with . - -

UNITOLOGY

⤴	⤵	∩	⤴	⤵	∩	∩	∩	∩	∩	∩	∩
A	B	C	D	E	F	G	H	I	J	K	L
∩	∩	∩	∩	∩	∩	∩	∩	∩	∩	∩	∩
N	O	P	Q	R	S	T	U	V	W	X	Y
∩	∩	∩	∩	∩	∩	∩	∩	∩	∩	∩	∩
1	2	3	4	5	6	7	8	9	10		
			∩	∩	∩	∩	∩	∩	∩		
			SS	TH	DBL LTR	QUESTION MARK	EXCLAMATION POINT				

STARWARS ALPHABET

⤴	∩	∩	∩	∩	∩	∩	∩	∩	∩
A	B	C	Ch	D	E	Ae	Eo	F	G
aurek	besh	creth	cherek	dorn	esk	enth	onith	furn	grek
∩	∩	∩	∩	∩	∩	∩	∩	∩	∩
H	I	J	K	Kh	L	M	N	Ng	O
herf	isk	jenth	krill	kreth	lesh	mers	nerm	nen	usk
∩	∩	∩	∩	∩	∩	∩	∩	∩	∩
Oo	P	Q	R	S	Sh	T	Th	U	V
oreth	peeth	qek	resh	seenth	shen	trill	thesh	usk	vev
∩	∩	∩	∩	∩	∩	∩	∩	∩	∩
W	X	Y	Z	,	.	?	!	:	;
wesk	xesh	yirt	zerek						
-	/	'	'	∩	∩	∩	∩	∩	∩
-	/	'	'	"	"	(	)	credits	

THE ONE FOR THE DRAGON ALPHABET

∩	∩	∩	∩	∩	∩	∩	∩	∩	∩
A	aa	ah	B	D	E	ei	ey	F	G
∩	∩	∩	∩	∩	∩	∩	∩	∩	∩
I	ii	J	K	L	M	N	O	oo	P
∩	∩	∩	∩	∩	∩	∩	∩	∩	∩
R	S	T	u	v	w	x	Y	Z	

### MALACHIM ALPHABET

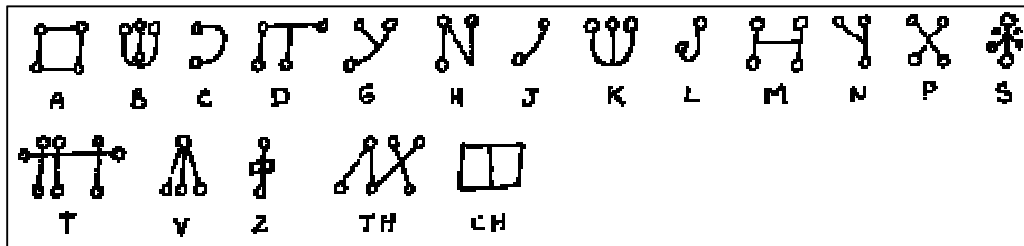
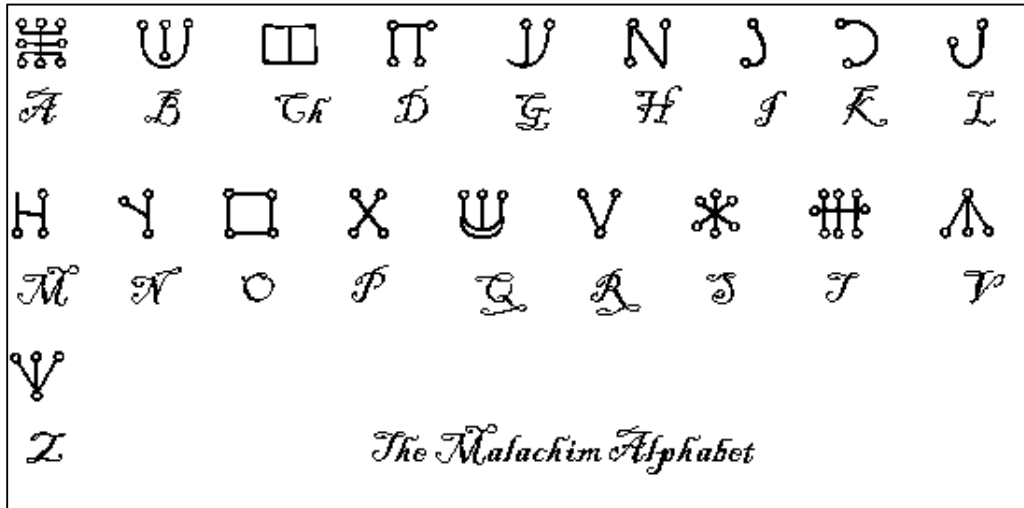

### DEMON SCRIPT

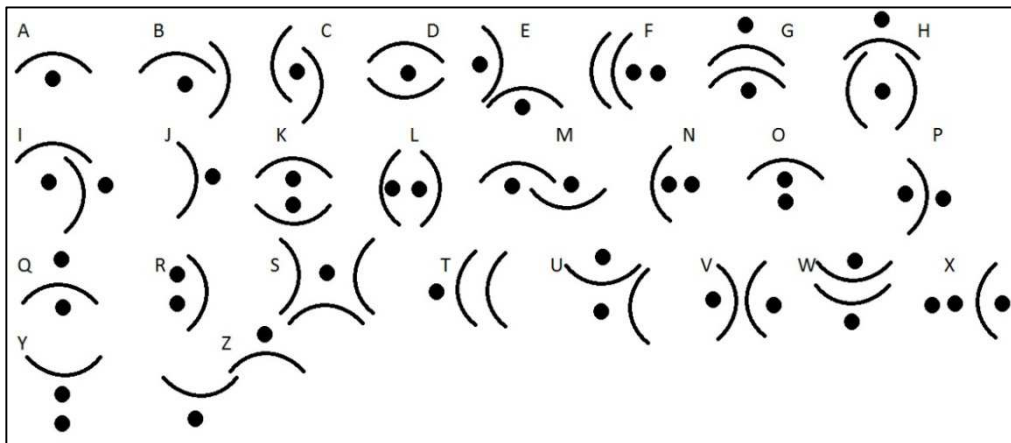

### ANGELIC SCRIPT

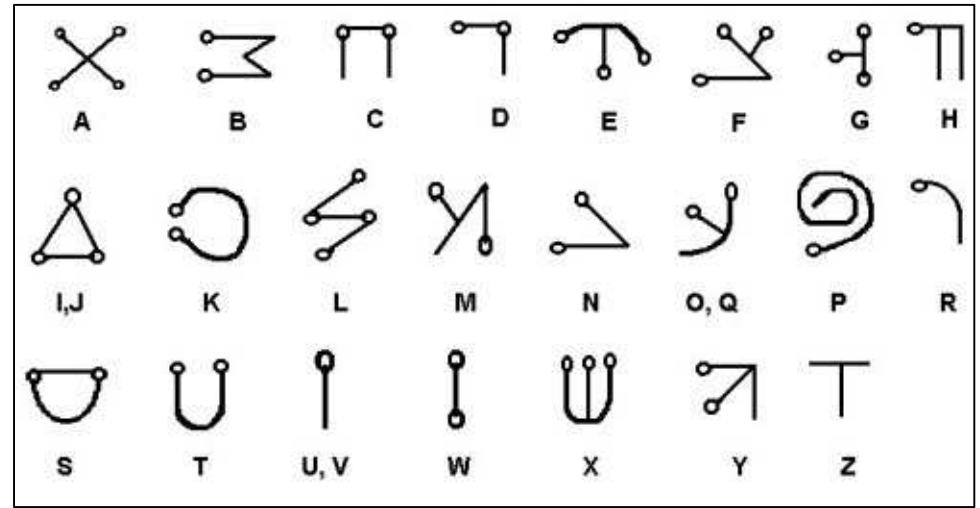

### FICTIONAL ALPHABET

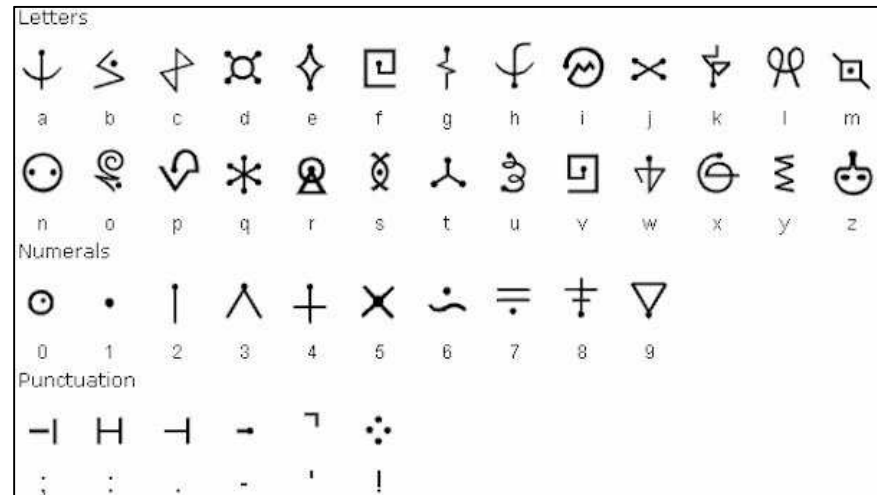

### TENCTONESE ALPHABET

Printed alphabet

a	b	c	d	e	f	g	h	i	j	k	l	m
n	o	p	q	r	s	t	u	v	w	x	y	z

Cursive alphabet

a	b	c	d	e	f	g	h	i	j	k	l	m
n	o	p	q	r	s	t	u	v	w	x	y	z

Numerals

0	1	2	3	4	5	6	7	8	9	&

### THE UTOPIAN ALPHABET

a	b	c	d	e	f	g	h	i	k	l
m	n	o	p	q	r	s	t	v	x	y

### ZENTLARDY ALPHABET

A	B	C	D	E	F	G	H	I	J	K	L	M
N	O	P	Q	R	S	T	U	V	W	X	Y	Z

0	1	2	3	4	5	6	7	8	9

### MATORAN ALPHABET



























a	b	c	d	e	f	g	h	i	j	k	l	m
n	o	p	q	r	s	t	u	v	w	x	y	z

1	2	3	4	5	6	7	8	9	0



























### 1612 / STANDARD GALACTIC ALPHABET

a	b	c	d	e	f	g	h	i	j	k	l	m	n
o	p	q	r	s	t	u	v	w	x	y	z		

### HALO COVENANT ALPHABET





















								
a	b	c	d	e	f	g	h	i
								
j	k	l	m	n	o	p	q	r
								
s	t	u	v	w	x	y	z	

### HYMMNOS ALPHABET

												
a	b	c	d	e	f	g	h	i	j	k	l	m
												
n	o	p	q	r	s	t	u	v	w	x	y	z

### ANTIKER CODE

A=	G=	M=	S=	Y=	4=
B=	H=	N=	T=	Z=	5=
C=	I=	O=	U=	0=	6=
D=	J=	P=	V=	1=	7=
E=	K=	Q=	W=	2=	8=
F=	L=	R=	X=	3=	9=

-											-
0	1	2	3	4	5	6	7	8	9	#	,
nel	nnoi	ji	dri	fef	vira	ixe	hept	oct	nei		
	-										
-	/	:	<	=	>	=>	>>	Xc=	->	<-X	
						tab	tras	xeku	pass	(s)pag	



### HYLIAN ALPHABET

⌠	Ⓛ	ⓐ	ⓑ	Ⓒ	Ⓓ	Ⓔ	Ⓕ	Ⓖ	Ⓗ	Ⓙ	Ⓚ	Ⓛ
Ⓖ	Ⓓ	ⓐ	ⓑ	Ⓒ	Ⓓ	Ⓔ	Ⓕ	Ⓖ	Ⓗ	Ⓙ	Ⓚ	Ⓛ
A	B	C	D	E	F	G	H	I	J	K	L	
Ⓜ	Ⓝ	ⓔ	ⓕ	ⓖ	ⓗ	Ⓢ	Ⓣ	Ⓤ	Ⓥ	Ⓦ		
Ⓜ	Ⓝ	ⓔ	ⓕ	ⓖ	ⓗ	Ⓢ	Ⓣ	Ⓤ	Ⓥ	Ⓦ		
M	N	O	P	Q	R	S	T	U	V	W		
Ⓡ	Ⓨ	Ⓩ	,	.	;	:	Ⓝ					
Ⓡ	Ⓨ	Ⓩ	,	.	;	:	Ⓝ					

At left are, from left to right, X, Y, Z, Comma, Period, Semicolon, Colon, and Exclamation Point.

### MODERN HYLIAN SCRIPT (NUMBERS)

Ⓛ	Ⓛ	Ⓛ	Ⓛ	Ⓛ	Ⓛ	Ⓛ	Ⓛ	Ⓛ	Ⓛ
1	2	3	4	5	6	7	8	9	0

### CYRILLIC NUMBERS

А	В	Г	Д	Е	С	З	И	Θ
1	2	3	4	5	6	7	8	9
І	К	Л	М	Н	Ќ	О	П	Ч(С)
10	20	30	40	50	60	70	80	90
Р	С	Т	У	Ф	Х	Ψ	Ω	Ц
100	200	300	400	500	600	700	800	900

### EARLY CYRILLIC SCRIPT

А	Б	В	Г	Д	Е	Ж	С	З	И	І
К	Л	М	Н	О	П	С	Р	С	Т	Ѡ ѡ
Ф	Х	Ω	Ц	Ч	Ш	Щ	Ъ	Ы	Ь	Ѣ
Є	Ю	А	Ѧ	ѧ	Ѩ	ѩ	Ѫ	ѫ	Ѭ	ѭ

### ANCIENT LATIN ALPHABET

Ⓛ	Ⓛ	Ⓛ	Ⓛ	Ⓛ	Ⓛ	Ⓛ	Ⓛ	Ⓛ	Ⓛ	
L	K	I	H	Z	F	E	D	C	B	A
[l]	[k]	[i]	[h]	[z]	[f]	[e]	[d]	[k]	[b]	[a]
Ⓛ	Ⓛ	Ⓛ	Ⓛ	Ⓛ	Ⓛ	Ⓛ	Ⓛ	Ⓛ	Ⓛ	
X	U	T	S	R	Q	P	O	N	M	
[ks]	[u/w]	[t]	[s]	[r]	[k <sup>w</sup> ]	[p]	[o]	[n]	[m]	

## ANCIENT & CLASSIC GREEK ALPHABET

Α Δ Β Α Λ	Α Τ Τ Ι Α Η	Α Τ Ο Ζ	Α Θ Η Θ	Α Τ Η	Α Τ Η Ι	Ζ Ε	Α Τ Δ Ε Δ	Α Μ Μ Α Λ	Α Τ Η Β	Α Φ Λ Α
labda	kappa	iota	theta	eta	zeta	ei	delta	gamma	beta	alpha
l	k	i	th	i	z	e/ē	d	g	b	a
Ζ Ε Χ	Ζ Ε Φ	Υ	Υ Α Τ	Α Μ Λ Ζ Σ	Ρ Ο	Ρ Ε Π	Υ Ο	Ζ Ε Ξ	Υ Ν	Υ Μ
chei	phei	u	tau	sigma	ro	pei	ou	xei	nu	mu
ch	ph	u/y	t	s	r	p	o	x	n	m

Α α	Β β	Γ γ	Δ δ	Ε ε	Ζ ζ	Η η	Θ θ	Ι ι	Κ κ	Λ λ	Μ μ
ἄλφα	βῆτα	γάμμα	δέλτα	ἕψιλόν	ζῆτα	ἦτα	θῆτα	ἰώτα	κάππα	λάμβδα	μῦ
alpha	beta	gamma	delta	epsilon	zeta	eta	theta	iota	kappa	lambda	mu
a	b	g	d	e	z	ē	th	i	k	l	m
[a, a:]	[b]	[g]	[d]	[e]	[zd/dz]	[ε:]	[tʰ]	[i, i:]	[k]	[l]	[m]
Ν ν	Ξ ξ	Ο ο	Π π	Ρ ρ	Σ σ ζ	Τ τ	Υ υ	Φ φ	Χ χ	Ψ ψ	Ω ω
νῦ	ξεῖ	ὀμικρόν	πεῖ	ῥῶ	σίγμα	ταῦ	ὑψιλόν	φεῖ	χεῖ	ψεῖ	ὤμέγα
nu	xi	omikron	pi	rho	sigma	tau	upsilon	phi	chi	psi	omega
n	ks, x	o	p	r, rh	s	t	u, y	ph	kh, ch	ps	ō
[n]	[ks]	[o]	[p]	[r]	[s, z]	[t]	[y, y:]	[pʰ]	[kʰ]	[ps]	[ɔ:]

LANGUAGE	DIGITS
multiple	9 8 7 6 5 4 3 2 1 0
Arabic	٩ ٨ ٧ ٦ ٥ ٤ ٣ ٢ ١ ٠
Persian / Urdu	۹ ۸ ۷ ۶ ۵ ۴ ۳ ۲ ۱ ۰

## MODERN CYRILLIC SCRIPT

А	Б	В	Г	Ґ	Д	Ђ	Ѓ	Е	Ё
A	Be	Ve	Ge	Ge upturn	De	Dje	Gje	Ye	Yo
Є	Ж	З	Ѕ	С	И	І	Ї	Й	Ј
Yest	Zhe	Ze	Zje	Dze	I	Dotted I	Yi	Short I	Je
К	Л	Љ	М	Н	Њ	О	П	Р	С
Ka	El	Lje	Em	En	Nje	O	Pe	Er	Es
Ѓ	Т	Ѡ	Ќ	У	Ў	Ф	Х	Ц	Ч
[ɕ]	Te	Tshe	Kje	U	Short U	Ef	Kha	Tse	Che
Џ	Ш	Щ	Ъ	Ы	Ь	Э	Ю	Я	
Dzhe	Sha	Shcha	Hard sign (Yer)	Yery	Soft sign (Yeri)	E	Yu	Ya	

## FENICISCH

	'		Т		P
	B		Y		S
	G		K		Q
	D		L		R
	H		M		Š
	W		N		T
	Z		S		
	H		O		

## DNI NUMERALS

0	1	2	3	4
5	6	7	8	9
10	11	12	13	14
15	16	17	18	19
20	21	22	23	24

Place-value 25	Single-digit 25	"Cyclical" zero

86:	238:
$3 \times 25 + 11$	$9 \times 25 + 13$

## GLAGOLICTIC ALPHABET

a	b	v	g	d	e	ž	z	z	i
i	g	k	l	m	n	o	p	r	s
t	u	f	ch	o	št	c	č	š	b
y	b	ě	ju	e	e	je	je	f	y

## GEORGE WASHINGTON KEY

a	b	c	d	e	f	g	h	i	j	k	l	m
n	o	p	q	r	s	t	u	v	w	x	y	z



# YINYANG ALPHALINES

## Consonants

p[p]	b[b]	t[t]	d[d]	c'[ç]	j[ɟ]	k[k]	g[g]	c[ʔ]
f[f]	v[v]	s[s]	z[z]	s'[ʃ]	z'[ʒ]	x[x]	q[ç]	h[h]
l[l]	r[r]	m[m]	n[n]	ñ[ɲ]	n'[ŋ]	w[w]		

## Vowels

i[i]	ɪ/ə[ɪ/ə]	u[u]
e[e]	o[o]	
ê[ɛ]	ô[ɔ]	
a[a]	â[b]	

## Numerals

1	2	3
4	5	6
7	8	9
	0	

## Punctuation

,	.
¿	?
;	:
“	”

## Accents

ô	ó	ö	ô	ö

# THREE SQUARES CIPHER

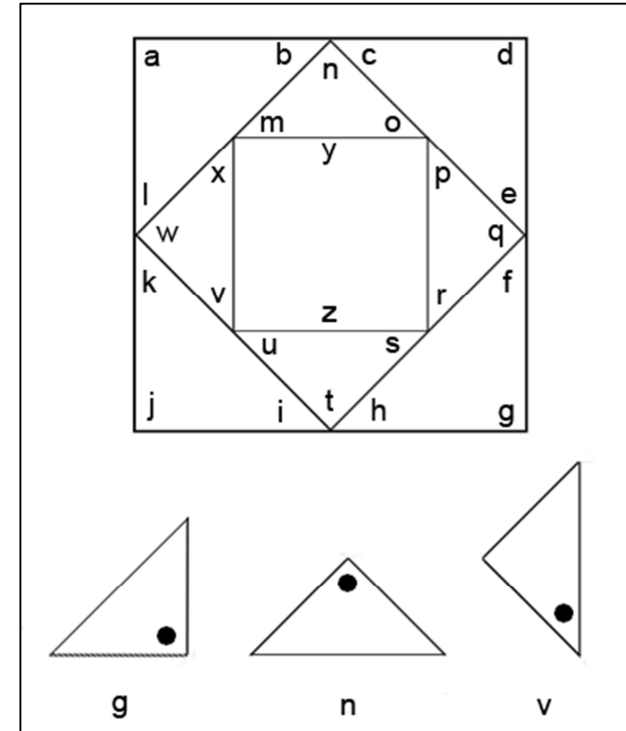

BASIC CIPHERS OF THE MONKS  
BASINGSTOKE CIPHER  
STANDARD CISTERNIAN  
CISTERNIAN CIPHERS  
HEIDELBERGER CIPHERS  
ATLANTEAN ALPHABET  
CIRTH ALPHABET TOLKIEN  
SARATI ALPHABET TOLKIEN  
URUK RUNES ALPHABETTOLKIEN  
DRAGON RUNES  
TOLKIENS SCRIPTS  
ATH ALPHABET  
ARCADIAN ALPHABET  
ANCIENT ALPHABET  
AUREK-BESK ALPHABET  
OLD HYLIAN SYLLABARY  
FONIC ALPHABET  
DAEDRIC (SKYRIM)  
DRACONIC ALPHABET  
TENGWAR (ELVISH)  
GNOMISCH ALPHABET  
SKY ALPHABET  
DRACHENSPRACHE  
SKYRIM  
SKYRIM'S DRAGON ALPHABET  
SKYRIM DRAGON CIJFERS

ANCIENT BRANDOBIAN  
HEAIAIAANS  
ELVISH ALPHABET  
DOTHRAKI (GAME OF THRONES)  
DWEMER  
AYLEID  
FALMER  
RUNES ALPHABET 1889  
RUNES  
KLASSISCH RUNEN  
MONDRUNEN  
ROVAS-SVABVANY RUNEN  
FUTHARKEN  
GERMANISCHE RUNEN  
ANGELSAKSICHEN RUNEN  
ALTERES FUTHARH  
GOTISCH RUNENALFABET  
INKUARE / MADOKA RUNES  
OPHIDIAN RUNES  
GARGISH & Runic ALPHABET  
FUTURAMA ALIEN ALPHABET  
ROMULAN ALPHABET  
KLINGON ALPHABET  
STANDARD GALACTIC ALPHABET  
VISITORS ALPHABET  
ZODIAK

CYBERTRONIAN  
KRYPTONIAN ALPHABET  
SPACE INVADERS  
ATLANTEAN  
ENOCHIAN  
ALIEN VISITOR  
ENCHANTMENT TABLE CODE  
STANDARD GALACTIC ALPHABET  
UNITOLOGY  
STARWARS ALPHABET  
THE ONE FOR THE DRAGON  
MALACHIM ALPHABET  
ANGELIC SCRIPT  
DEMON SCRIPT  
FICTIONAL ALPHABET  
TENCTONESE ALPHABET  
UTOPIAN ALPHABET  
ZENTLARDY ALPHABET  
MATORAN ALPHABET  
1612  
HALO COVENANT ALPHABET  
HYMMNOS ALPHABET  
ANTIKER CODE  
HYLIAN ALPHABET  
MODERN HYLIAN NUMBERS  
CYRILLIC NUMBERS

**EARLY CYRILLIC SCRIPT**

**ANCIENT LATIN ALPHABET**

**ANCIENT & CLASSIC GREEK ALPHABET**

**MODERN CYRILLIC SCRIPT**

**FENICISCH**

**DNI NUMERALS**

**GLAGOLICTIC ALPHABET**

**GEORGE WASHINGTON KEY**

**KABOUTER ALFABET**

**MAZE CODE**

**YINYANG ALPHALINES**

**THREE SQUARES CIPHER**

# MIJN CODEBOEK 3.1

## deel 3





## THEBAN ALPHABET

A	B	C	D	E	F
G	H	I/J	K	L	M
N	O	P	Q	R	S
T	U/V/W	X	Y	Z	End of sentence

## THEBAN SCRIPT

A		H		O		V	
B		I		P		W	
C		J		Q		X	
D		K		R		Y	
E		L		S		Z	
F		M		T			
G		N		U			

## INDISCH TELLEN

European (descended from the West Arabic)	0	1	2	3	4	5	6	7	8	9
Arabic-Indic	•	١	٢	٣	٤	٥	٦	٧	٨	٩
Eastern Arabic-Indic (Persian and Urdu)	•	۱	۲	۳	۴	۵	۶	۷	۸	۹
Devanagari (Hindi)	०	१	२	३	४	५	६	७	८	९
Tamil		௦	௧	௨	௩	௪	௫	௬	௭	௮

## BRAHMI TELLEN

1	2	3	4	5	6	7	8	9
—	=	≡	+	h	୩	୪	୫	୬

### HIERATISCH TELLEN

1	II	III	IIII	𐤀	𐤁	𐤂	𐤃	𐤄
1	2	3	4	5	6	7	8	9
𐤅	𐤆	𐤇	𐤈	𐤉	𐤊	𐤋	𐤌	𐤍
10	20	30	40	50	60	70	80	90
𐤎	𐤏	𐤐	𐤑	𐤒	𐤓	𐤔	𐤕	𐤖
100	200	300	400	500	600	700	800	900
𐤗	𐤘	𐤙	𐤚	𐤛	𐤜	𐤝	𐤞	𐤟
1000	2000	3000	4000	5000	6000	7000	8000	9000

𐤀 𐤁 𐤂 𐤃 𐤄 𐤅 𐤆 𐤇 𐤈 𐤉 𐤊 𐤋 𐤌 𐤍 𐤎 𐤏 𐤐 𐤑 𐤒 𐤓 𐤔 𐤕 𐤖 𐤗 𐤘 𐤙 𐤚 𐤛 𐤜 𐤝 𐤞 𐤟 = 9857

### GRIEKS TELLEN

α	β	γ	δ	ε	ς	ζ	η	θ
1	2	3	4	5	6	7	8	9
ι	κ	λ	μ	ν	ξ	ο	π	ϛ
10	20	30	40	50	60	70	80	90
ρ	σ	τ	υ	φ	χ	ψ	ω	Ϟ
100	200	300	400	500	600	700	800	900
Ϡ	ϡ	Ϣ	ϣ	Ϥ	ϥ	Ϧ	ϧ	Ϩ
1000	2000	3000	4000	5000	6000	7000	8000	9000

### MOBIELTJE

A, B, C	= 2
D, E, F	= 3
G, H, I	= 4
J, K, L	= 5
M, N, O	= 6
P, Q, R, S	= 7
T, U, V	= 8
W, X, Y, Z	= 9
+	= 0

### PC TOETSEN

1	= !	6	= &
2	= "	7	= /
3	= §	8	= (
4	= \$	9	= )
5	= %	0	= =

### PC TOETSEN AMERIKAANS

1	= !	6	= ^
2	= @	7	= &
3	= #	8	= *
4	= \$	9	= (
5	= %	0	= )

### ZAMORISCHE GETALLEN

0	1	2	3	4	5	6	7
---	---	---	---	---	---	---	---

## HEBREEUWS ALFABET

Tet	Chet	Zajin	Wav	Hee	Dalet	Gimmel	Beet	Alef
T	Ch	Z	W/O/OE	H	D	G	B	-
Samech	Noen	Noen	Mem	Mem	Lamed	Chaf	Kaf/Chaf	Jod
(S)	(N)	(N)	(M)	(M)	(L)	(Ch)	(K/Ch)	(J)
Tav	Sjien	Reesj	Kof	Tsadi	Tsadi	Fee	Pee/Fee	Ajin
(T/S)	(Sj/S)	(R)	(K)	(Ts)	(Ts)	(F)	(P/F)	-

## HEBREEUWSE CIJFERS

Hebreeuws	Decimaal	Teken
Alef	1	א
Beet	2	ב
Gimmel	3	ג
Dallet	4	ד
Hee	5	ה
Waw	6	ו
Zajien	7	ז
Chet	8	ח
Tet	9	ט
Jod	10	י

Kaf	20	כ
Lammed	30	ל
Mem	40	מ
Noen	50	נ
Samech	60	ס
Ajien	70	ע
Pee	80	פ
Tsaddie	90	צ
Koef	100	ק
Reesj	200	ר
Sjien	300	ש
Taw	400	ת
Kaf sofiet	500	ך
Mem sofiet	600	ם
Noen sofiet	700	ן
Pee sofiet	800	ף
Tsaddie sofiet	900	ץ

Het Hebreeuws wordt van rechts naar links geschreven, in plaats van het Nederlands dat van links naar rechts geschreven wordt.

Het Hebreeuwse alfabet heeft geen klinkers.

Het Hebreeuws heeft een alfabetisch getal systeem: dit systeem kent geen symbool voor nul, en de letterwaarde van de individuele letters worden opgeteld. Elk cijfer (1, 2, ..., 9) wordt weergegeven door een aparte letter, elk tiental (10, 20, ..., 90) door een aparte letter, en elk honderdtal (100, 200, ..., 900) een aparte letter.



























Dit systeem van Hebreeuwse cijfers wordt vooral gebruikt in het oudere Hebreeuws. In het modern Hebreeuws maakt men meestal gebruik van cijfers uit het decimale systeem.

Het additieve karakter van het systeem kan worden geïllustreerd aan het voorbeeld voor het getal 177, dat kan worden weergegeven als טעק wat overeenkomt met  $100 + 70 + 7 = 177$ .

De getallen 15 en 16 worden weergegeven als respectievelijk טו (=9+6) en טז (=9+7), in plaats van יה' en יו'. De laatste, meer voor de hand liggende combinatie wordt niet gebruikt om een letterreeks te vermijden die deel uitmaakt van de naam van God volgens het jodendom.

zie verder: [http://nl.wikipedia.org/wiki/Hebreeuwse\\_cijfers](http://nl.wikipedia.org/wiki/Hebreeuwse_cijfers)



























## BOOM CODE

3421  ABA a	4312  CAB b	4321  ACC c	3412  ABB d	2134  BAB e	4321  CAA f	4312  ACB g
2134  BAC h	1234  BBB i	2134  CAC j	4321  ACA k	3421  ABC l	4321  AAC m	4312  AAB n
4321  AAA o	1243  CBA p	4321  CCA q	2143  BAA r	1243  BCA s	1243  BBA t	1234  BBC u
1234  BCB v	1234  BCC w	1234  CBC x	4312  CCB y	1234  CBB z	4312  CCC	

## NEW ZEALAND BRANDING SYSTEM

									
1	2	3	4	5	6	7	8	9	0

## HB3D

 A	 B	 C	 D
 E	 F	 G	 H
 I	 J	 K	 L
 M	 N	 O	 P
 Q	 R	 S	 T
 U	 V	 W	 X
	 Y	 Z	

FEZ CODE

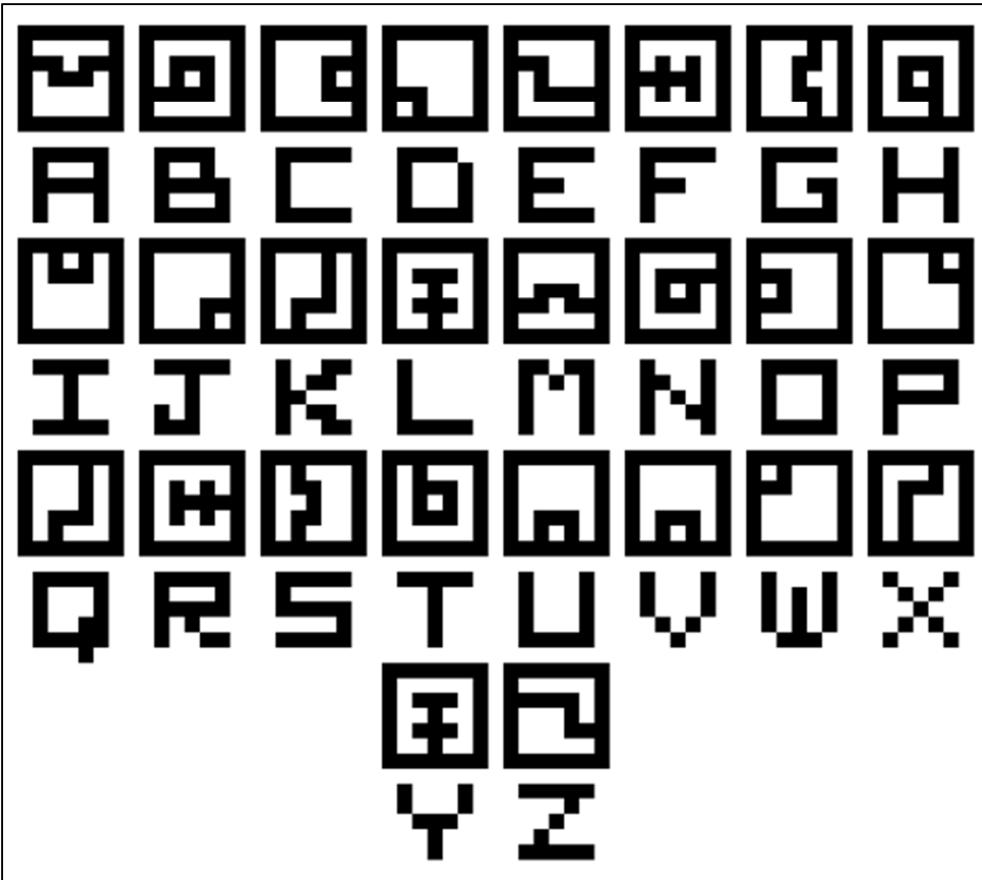

6FEBRUARISCHRIFT

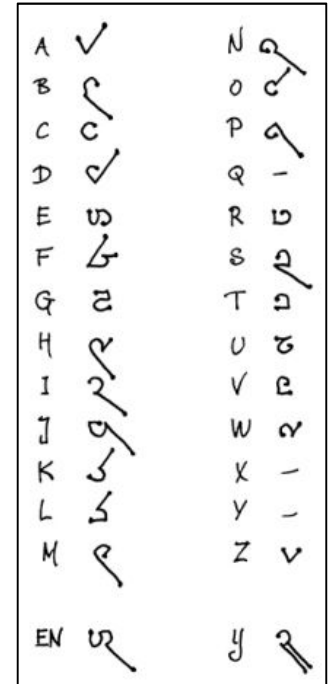
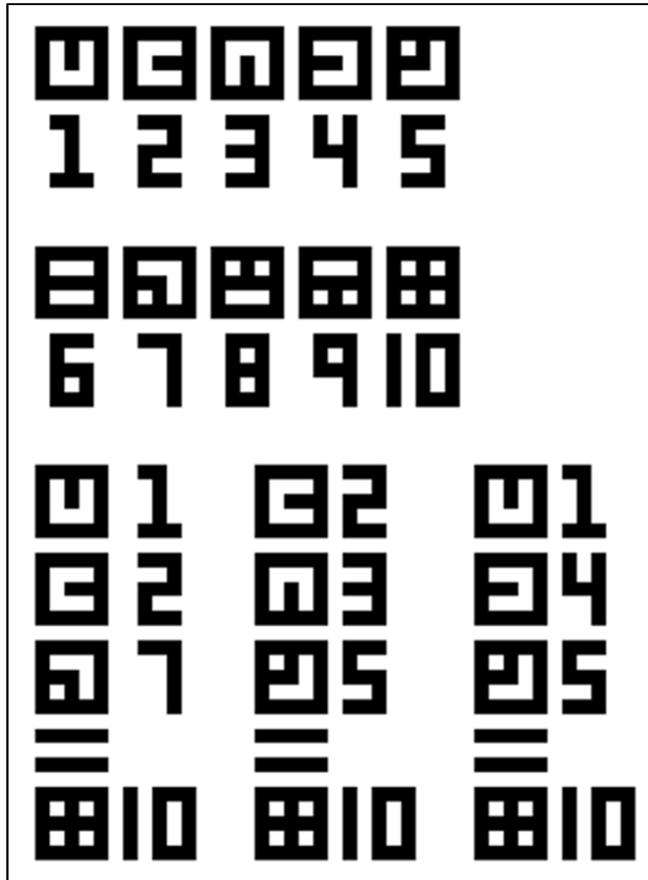

COORGI COX ALPHABET



ANGLE BRANDING SYSTEM

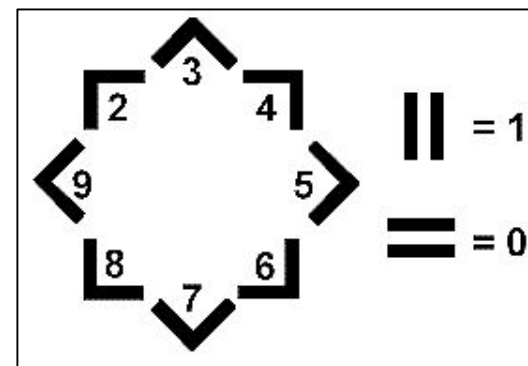

## TEK BIN

■	┆	■	┆	■	┆	┆	┆	■	■	┆	┆	■	■	■
a	b	c	d	e	f	g	h	i	j	k	l	m	n	o
┆	┆	┆	■	┆	■	┆	┆	┆	■	■	■	■	■	■
p	q	r	s	t	u	v	w	x	y	z	ä	ö	ü	ß

**Other symbols**

┆	≡	■	┆		-	=	≡	≡
comma	semi-colon	full stop	colon	+	*	-	+	=

**Numerals**  
regular binary :

	■	■	■	■	■	■	■	■	■
0	1	2	3	4	5	6	7	8	9

vertical (one-key) binary :

	■	■	■	■	■	■	■	■	■
0	1	2	3	4	5	6	7	8	9

## POOL BALLEEN



## VIOZIAANS

Nederlands:	a	b	c	d	e	f	g	h	i	j	k	l	m	n	o	p	q	r	s	t	u	v	w	x	y	z
Vioziaans:	u	x	y	z	o	t	v	w	a	n	p	q	r	s	i	h	d	k	l	m	e	b	c	f	j	g

<https://drabkikker.wordpress.com/talen-schriften/vioziaans/>

Fenicisch	Grieks	Latijn
𐤀	A	A
𐤁	B	B
𐤂	Γ	C
𐤃	Δ	D
𐤄	E	E
𐤅		F
𐤆	Z	Z
𐤇	H	H
𐤈	Θ	
𐤉	I	I
𐤊	K	K
𐤋	Λ	L
𐤌	M	M
𐤍	N	N
𐤎	Ξ	
𐤏	O	O
𐤐	Π	P
𐤑		Q
𐤒	P	R
𐤓	Σ	S
𐤔	T	T

### THE DANCING MEN

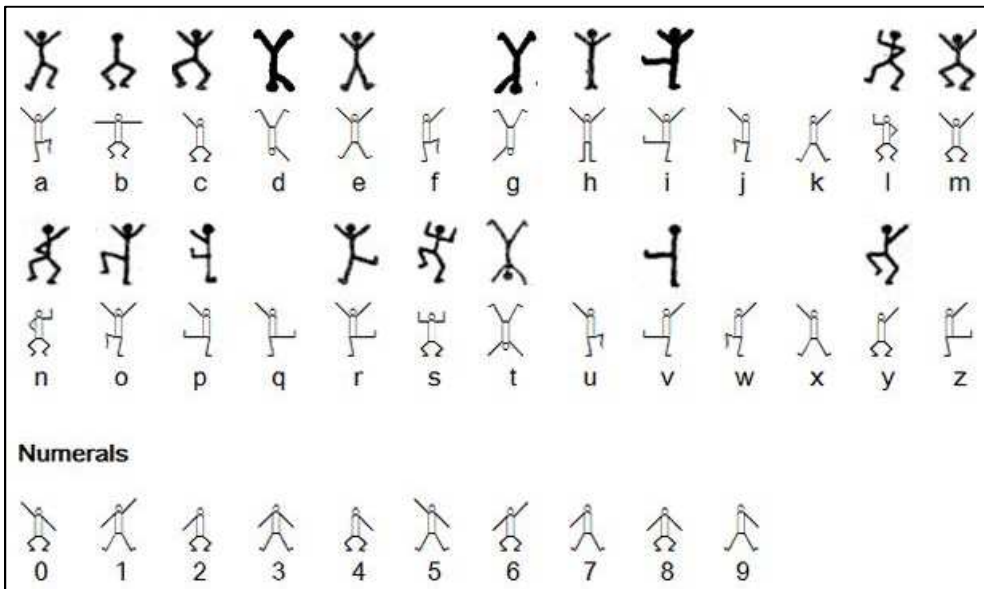

### DANCING MAN CODE (SHERLOCK HOLMES)

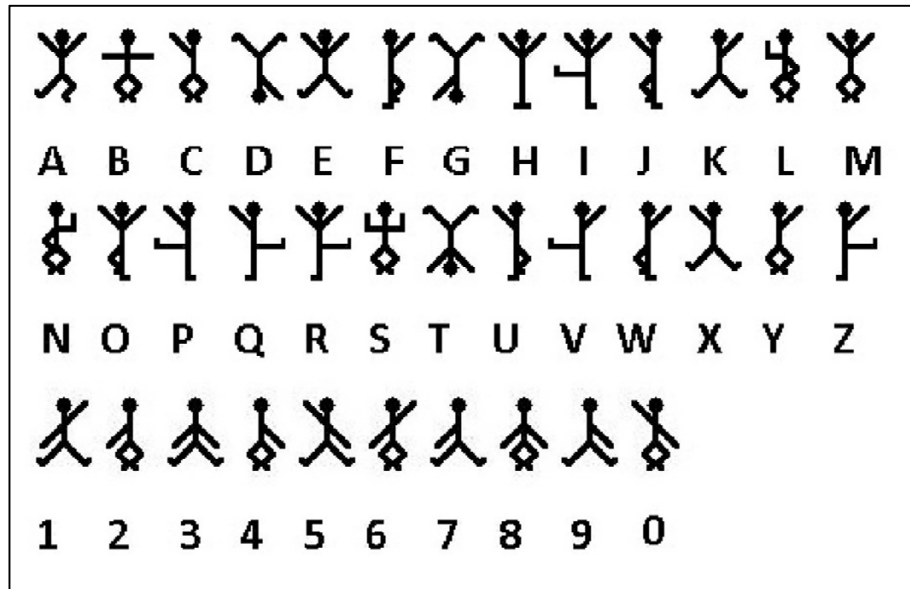

### ERLKONINGSCHRIFT

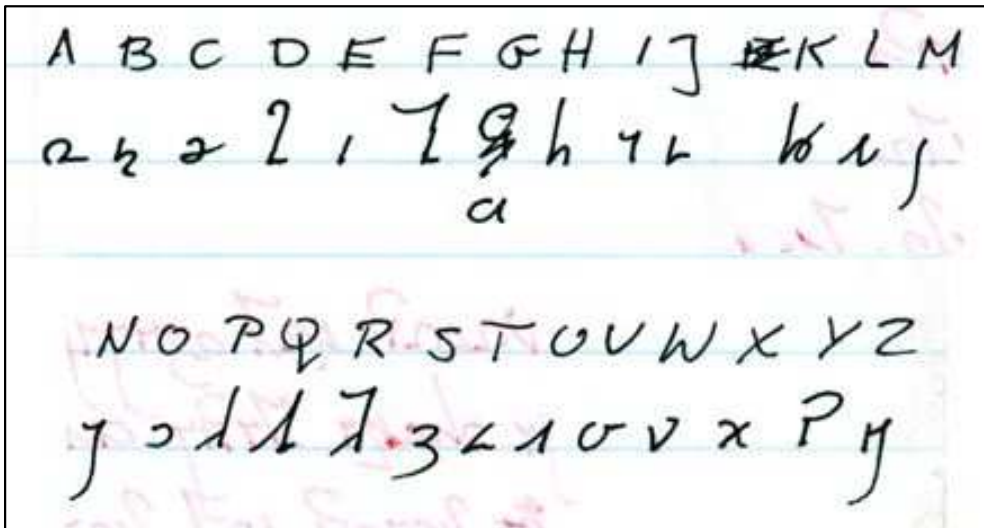

### PIPELINE CODE

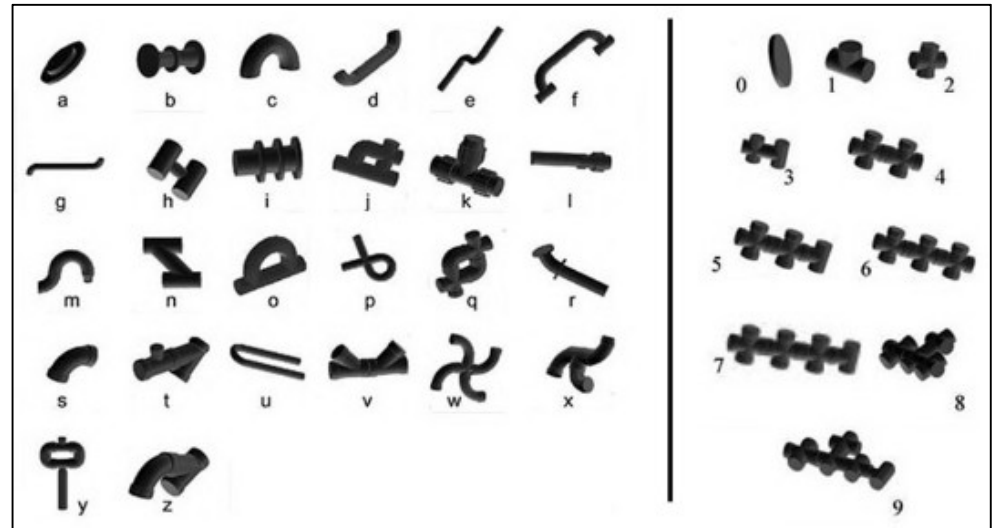

### JAPANS TELLEN

0	ZERO	零 / 〇	
1	ICHI	一	
2	NI	二	
3	SAN	三	<b>30 =</b>
4	YON	四	三 (3) + (10) =
5	GO	五	三十 (SAN-JŪ)
6	ROKU	六	
7	NANA	七	
8	HACHI	八	<b>31 =</b>
9	KYŪ	九	三 (3) + (10) - (1) =
10	JŪ	十	三十一 (SAN-JŪ-ICHI)
20	NIJŪ	二十	
100	HYAKU	百	
1000	SEN	千	
10000	MAN	万	

### ROMEINSE GETALLEN

I	II	III	IV	V	VI	VII	VIII	IX	X
1	2	3	4	5	6	7	8	9	10
XI	XX	XXX	XL	L	LX	LXX			
11	20	30	40	50	60	70			
									LABBÉ
LXXX	XC	XCVIII	XCIX	C	D	M			
80	90	98	99	100	500	1000			

### HANGEUL ALPHABET/KOREAN ALPHABET

가	갸	나	디	띠	리	미	비	뵤	
giyeok	ssang giyeok	nieun	digeut	ssang digeut	rieul	mieum	bieup	ssang bieup	
g, k	kk	n	d, t	tt	l	m	b, p	pp	
k, g	kk	n	t, d	tt	l, r	m	p, b	pp	
[k/g]	[kʰ]	[n]	[tʰ/d]	[tʰ]	[l/r]	[m]	[p/b]	[pʰ]	
ㅏ	ㅑ	ㅇ	ㅓ	ㅕ	ㅗ	ㅛ	ㅜ	ㅠ	ㅎ
siot	ssang siot	ieung	jeut	ssang jeut	chieut	kiuek	tieut	pieup	hieut
s	ss	ng	j	jj	ch	k	t	p	h
s	ss	-ng	ch, j	tch	ch'	k'	t'	p'	h
[s]	[sʰ]	[∅/-ŋ]	[tʰ/dʒ]	[tʰʰ]	[tʰ]	[kʰ]	[tʰ]	[pʰ]	[h]

### GLAGOLITISCH TELLEN

Arab.	Glag.	Kyr.	Arab.	Glag.	Kyr.	Arab.	Glag.	Kyr.	Arab.	Glag.	Kyr.
1	ⲁ = a	a = a	10	Ⲛ = i	i = i	100	ⲃ = r	p = r	1000	Ⲙ = ċ	—
2	Ⲃ = b	v = v	20	ⲛ = k	k = k	200	Ⲅ = s	c = s	2000	ⲙ = ð	—
3	Ⲅ = v	r = g	30	ⲛ = ġ	n = l	300	Ⲇ = t	t = t	3000	Ⲛ = b	—
4	Ⲇ = g	d = d	40	ⲛ = k	m = m	400	Ⲉ = u	v = y	4000	Ⲟ = ð	—
5	Ⲇ = d	e = e	50	ⲛ = l	n = n	500	Ⲋ = f	ϕ = f	5000	Ⲣ = ju	—
6	Ⲉ = e	s = z	60	ⲛ = m	ǰ = x	600	Ⲍ = ch	x = ch	6000	?	—
7	Ⲉ = z	z = z	70	ⲛ = n	o = o	700	Ⲏ = ð	ψ = ps	7000	?	—
8	Ⲋ = z	n = i	80	ⲛ = o	n = p	800	Ⲑ = st	w = ð	8000	?	—
9	Ⲋ = z	e = f	90	ⲛ = p	ϥ = ċ	900	Ⲓ = c	ϣ = c	9000	Ⲟ? = e?	—



## GLAGOLITISCH ALPHABET

<b>A</b> = sĭh	<b>K</b> = Ҕ	<b>U</b> = ҔѠ	<b>0</b> = -
<b>B</b> = Ҕ	<b>L</b> = ҔѠ	<b>V</b> = ҔѠ	<b>1</b> = .rh
<b>C</b> = Ҕ	<b>M</b> = ҔѠ	<b>W</b> =	<b>2</b> = .se
<b>D</b> = ҔѠ	<b>N</b> = ҔѠ	<b>X</b> = ҔѠ	<b>3</b> = 00
<b>E</b> = Ҕ	<b>O</b> = ҔѠ	<b>Y</b> = ҔѠ	<b>4</b> = 7ad
<b>F</b> = ҔѠ	<b>P</b> = ҔѠ	<b>Z</b> = ҔѠ	<b>5</b> = 0b
<b>G</b> = ҔѠ	<b>Q</b> =		<b>6</b> = 3
<b>H</b> = ҔѠ	<b>R</b> = ҔѠ		<b>7</b> = 00
<b>I</b> = 8	<b>S</b> = ҔѠ		<b>8</b> = .0
<b>J</b> = ҔѠ	<b>T</b> = ҔѠ		<b>9</b> = ҔѠ

## HENOCHISCH CODE

	Klang	Titel		Klang	Titel		Klang	Titel
Ҕ	B	Pa	Ҕ	M	Tal	Ҕ	X	Pal
Ҕ	C/K	Veh	Ҕ	I/Y/J	Gon	Ҕ	O	Med
Ҕ	G	Ged	Ҕ	H	Na	Ҕ	R	Don
Ҕ	D	Gal	Ҕ	L	Ur	Ҕ	Z	Keph
Ҕ	F	Or	Ҕ	P	Mals	Ҕ	U/V/W	Van
Ҕ	A	Un	Ҕ	Q	Ger	Ҕ	S	Fam
Ҕ	E	Graph	Ҕ	N	Drux	Ҕ	T	Gisg

## POLYBIUS (5 und 6)

	1	2	3	4	5	
1	A	B	C	D	E	
2	F	G	H	I	J	K
3	L	M	N	O	P	
4	Q	R	S	T	U	
5	V	W	X	Y	Z	

	1	2	3	4	5	6
1	A	B	C	D	E	F
2	G	H	I	J	K	L
3	M	N	O	P	Q	R
4	S	T	U	V	W	X
5	Y	Z	0	1	2	3
6	4	5	6	7	8	9

## SPINTYPE

vowels:

⊙	⊙	⊙	⊙	⊙	⊙	⊙	⊙
a	e	i	o	u	a	a2	a3

consonants:

⊙	⊙	⊙	⊙	⊙	⊙	⊙	⊙	⊙	⊙
t/th	g	f/v	n	m	j/y	h	w	d	

⊙	⊙	⊙	⊙	⊙	⊙	⊙
k	r	s/sh/z	l	p	b	

numerals:

⊙	⊙	⊙	⊙	⊙	⊙	⊙	⊙	⊙	⊙
1	2	3	4	5	6	7	8	9	10

punctuation:

⊙	⊙	⊙	⊙
start of paragraph	start of sentence	start of word	comma



# BAUDOT

## Steuerzeichen

- . . . Leerzeichen, Buchstabentabelle benutzen
- . ○ . . . Leerzeichen, Zahlentabelle benutzen
- . . . Letztes Zeichen löschen

## Buchstabentabelle

## Zahlentabelle

.. ○.. A	○○ ○.. K	.. ○.. 1	○. ○.. .
.. ○○. É	○○ ○○. L	.. .○. 2	○. .○. 9/
.. .○. E	○○ .○. M	.. ..○ 3	○. ..○ 7/
.. .○○ I	○○ .○○ N	.. ○.○ 4	○. ○.○ 2/
.. ○○○ O	○○ ○○○ P	.. ○○○ 5	○. ○○○ '
.. ○.○ U	○○ ○.○ Q	.. ○○. 1/	○. ○○. :
.. ..○ Y	○○ ..○ R	.. .○○ 3/	○. .○○ ?
.○ ..○ B	○. ..○ S	.○ ○.. 6	○○ ○.. (
.○ ○.○ C	○. ○.○ T	.○ .○. 7	○○ .○. )
.○ ○○○ D	○. ○○○ V	.○ ..○ 8	○○ ..○ -
.○ .○○ F	○. .○○ W	.○ ○.○ 9	○○ ○.○ /
.○ .○. G	○. .○. X	.○ ○○○ 0	○○ ○○○ +
.○ ○○. H	○. ○○. Z	.○ ○○. 4/	○○ ○○. =
.○ ○.. J	○. ○.. -	.○ .○○ 5/	○○ .○○ £

# DECABIT

Code	Bitmuster	Code	Bitmuster	Code	Bitmuster	Code	Bitmuster	Code	Bitmuster	Code	Bitmuster	Code	Bitmuster		
0	---+--- +-	32	+--+--- +--	64	+--+--- +---	96	-++-+--- +---	16	---+--- +---	48	+--+--- +--	80	-++-+--- +---	112	-++-+--- +---
1	+----- +-	33	+----- +---	65	+----- ---	97	-++-+--- +---	17	+----- +---	49	+--+--- +--	81	-++-+--- +---	113	+----- +---
2	+----- +-	34	+--+--- +--	66	+--+--- +---	98	----- +---	18	+--+--- +--	50	+--+--- +--	82	+--+--- +--	114	+----- +---
3	+----- +-	35	+----- +-	67	+----- --	99	-++-+--- +---	19	+----- +-	51	+--+--- +--	83	+--+--- +--	115	+----- +---
4	----- ++	36	+--+--- +--	68	-+- +---	100	----- +---	20	+--+--- +--	52	+--+--- +--	84	-+- +---	116	-++-+--- +---
5	+----- --	37	+--+--- +--	69	+--+--- +--	101	-++-+--- +---	21	+----- +---	53	+--+--- +--	85	+--+--- +--	117	-++-+--- +---
6	+----- +-	38	+----- +---	70	+----- +---	102	-++-+--- +---	22	+----- +---	54	+--+--- +--	86	+--+--- +--	118	+----- +---
7	+----- +-	39	-+- +---	71	+----- +---	103	+----- +---	23	+----- +---	55	+--+--- +--	87	+----- +---	119	-++-+--- +---
8	+----- +-	40	+--+--- +--	72	-+- +---	104	+----- +---	24	+----- +---	56	+--+--- +--	88	+--+--- +--	120	+----- +---
9	+----- +-	41	+----- +---	73	+----- +---	105	+----- +---	25	+----- +---	57	+--+--- +--	89	+----- +---	121	+----- +---
10	+----- --	42	+----- +---	74	-+- +---	106	+----- +---	26	+----- +---	58	+--+--- +--	90	+----- +---	122	+----- +---
11	+----- +-	43	+----- +---	75	+--+--- +--	107	-++-+--- +---	27	+--+--- +--	59	+----- +---	91	+----- +---	123	+----- +---
12	+----- +-	44	+----- +---	76	+----- +---	108	+----- +---	28	+----- +---	60	+----- +---	92	+----- +---	124	+----- +---
13	+----- +-	45	+----- +---	77	+----- +---	109	+----- +---	29	+----- +---	61	+----- +---	93	+----- +---	125	+----- +---
14	+----- ++	46	+--+--- +--	78	+----- +---	110	+----- +---	30	+----- +---	62	+--+--- +--	94	+----- +---	126	+----- +---
15	----- +--	47	+----- +---	79	+----- +---	111	+----- +---	31	+----- +---	63	+----- +---	95	+----- +---		

# TOMTOM

/	//	///	////	^	^/	^^	^ \	^ \ \
a	b	c	d	e	f	g	h	i
v	v \	v \ \	v /	v //	^ \	/ \	^ \ v	^ \ /
j	k	l	m	n	o	p	q	r
v \	v \ \	v \ ^	v \ \	/ \	v /	w	^ \	
s	t	u	v	w	x	y	z	

### BACKSLASH

A		N	///
B	/	O	/\
C	\	P	\
D	/	Q	\ /
E	///	R	\ \
F	/\	S	\
G		T	\ /
H	IV	U	\ \
I	\	V	VI
J	/	W	V /
K	/ /	X	V\
L	/ \	Y	V
M	/	Z	V\

### ARCADIAN CODE

A=⊙	H=∫	O=(.)	V=∫,
B=∫	I=∫	P=∫	W=∫
C=C·	J=∫	Q=∫	X=∫
D=∫	K=i	R=∫	Y=∫
E=∫	L=∫	S=∫	Z=∫
F=∫	M=∫	T=∫	
G=∫	N=∫	U=∫	

### KLOK ALFABET

A	B	C	D	E	F	G	H	I	
J	K	L	M	N	O	P	Q	R	
S	T	U	V	W	X	Y	Z		

### BALLET CODE

a	b	c	d	e	f	g	h	i	
j	k	l	m	n	o	p	q	r	
s	t	u	v	w	x	y	z		



# ATBASH (HEBREW) CIPHER

## ATBASH (HEBREW) CIPHER

PSALM 115:1

BIBLIA HEBRAICA - HEBREW BIBLE

לא לנו יהוה לא-לנו כי-לשמך תן כבוד על-המרה על-אמתך:

11	10	9	8	7	6	5	4	3	2	1
ט	י	כ	ח	ז	ו	ה	ד	ג	ב	א
ל	מ	נ	ס	ע	פ	צ	ק	ר	ש	ת
12	13	14	15	16	17	18	19	20	21	22

כתרפ מצפצ כת-כרפ למ-כביל אמ ללמק זכ-ציגל זכתיאל:

Hebrew is written from right to left.

Five of the letters have a special form used only at the end of a word:

ך	k	ם	m	ן	n	ף	p	ץ	ts
---	---	---	---	---	---	---	---	---	----

Dan Thomasson, March 20, 2004

# BACONIAN CIPHER

a: AAAAA	g: AABBA	n: ABBAA	t: BAABA
b: AAAAB	h: AABBB	o: ABBAB	u/v: BAABB
c: AAABA	i/j: ABAAA	p: ABBBA	w: BABAA
d: AAABB	k: ABAAB	q: ABBBB	x: BABAB
e: AABAA	l: ABABA	r: BAAAA	y: BABBA
f: AABAB	m: ABABB	s: BAAAB	z: BABBB

*atbash cipher with associated quartertone scale*

ת ש ר ק ר ש ת right-to-left

left-to-right א ב ג ד ה ו ז ח ט י כ ל מ נ ס ע פ צ ק ר ש ת

ת ש ר ק ר ש ת right-to-left

left-to-right א ב ג ד ה ו ז ח ט י כ ל מ נ ס ע פ צ ק ר ש ת

D d D# d# E F f F# f# G g G#/Ab a A bb Bb b B C db Db d D

Tritone

א ב ג ד ה ו ז ח ט י כ ל מ נ ס ע פ צ ק ר ש ת

D d D# d# E F f F# f# G g G#/Ab a A bb Bb b B C db Db d D

## ATBASH

abcdefghijklmnopqrstuvwxyz  
ZYXWVUTSRQPONMLKJIHGFEDCBA

## CAESAR

abcdefghijklmnopqrstuvwxyz  
DEFGHIJKLMNOPQRSTUVWXYZABC





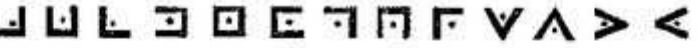

## MASON CIPHERS

  
 1 2 3 4 5 6 7 8 9 10 11 12 13

A point placed within each gives thirteen more, thus :



  
 1 2 3 4 5 6 7 8 9 10 11 12 13

Making a total of twenty-six, equal to the number of letters in the English alphabet.

There are two ways, at least, of combining and using these characters for the purposes of secret correspondence. One method is to call the first sign,  a; the same, with a point,  b, etc. Another is to apply them, in their regular course, to the first half of the alphabet,  a,  b, and so on, to m; after which, repeat them with a dot, beginning with  n,  o, etc., to  z.

The alphabet, according to the first method, stands thus :

  
 a b c d e f g h i j k l m

  
 n o p q r s t u v w x y z

According to the second method, thus :

  
 a b c d e f g h i j k l m



  
 n o p q r s t u v w x y z

## SANSKRIT CIJFERS

१	२	३	४	५	६	७	८	९	०
1	2	3	4	5	6	7	8	9	0

## ANCIENT BERBER

Ancient Berber (Horizontal)

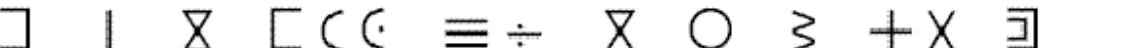

  
 > b ġ d w z ž z̄ ḥ t, d y k l

  
 m n s s² ġ f r š t t̄

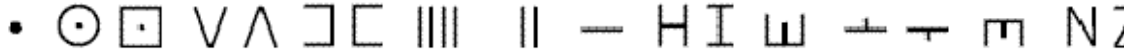
Ancient Berber (Vertical)

  
 > b ġ d h w z ž z̄ ḥ t, d y

  
 k l m n s s² ġ f q r š

  
 t t̄

## URDU CIJFERS

۰	۱	۲	۳	۴	۵	۶	۷	۸	۹	۱۰
صفر	ایک	دو	تین	چار	پانچ	چھ	سات	آٹھ	نو	دس
sifar	ek	do	tīn	chār	pānch	che	sāt	āth	nau	das
0	1	2	3	4	5	6	7	8	9	10





# WEBSCHRIFT

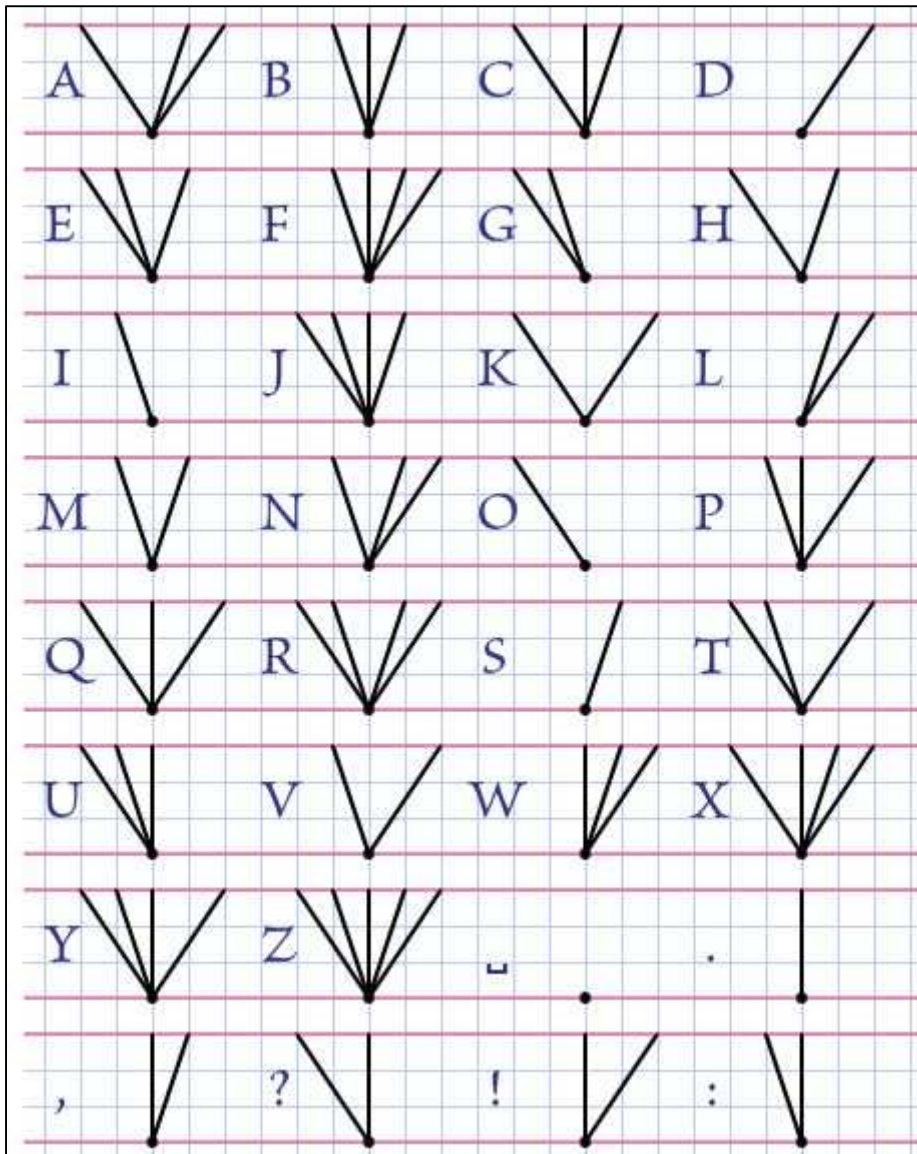

# CODIGO ALFABET

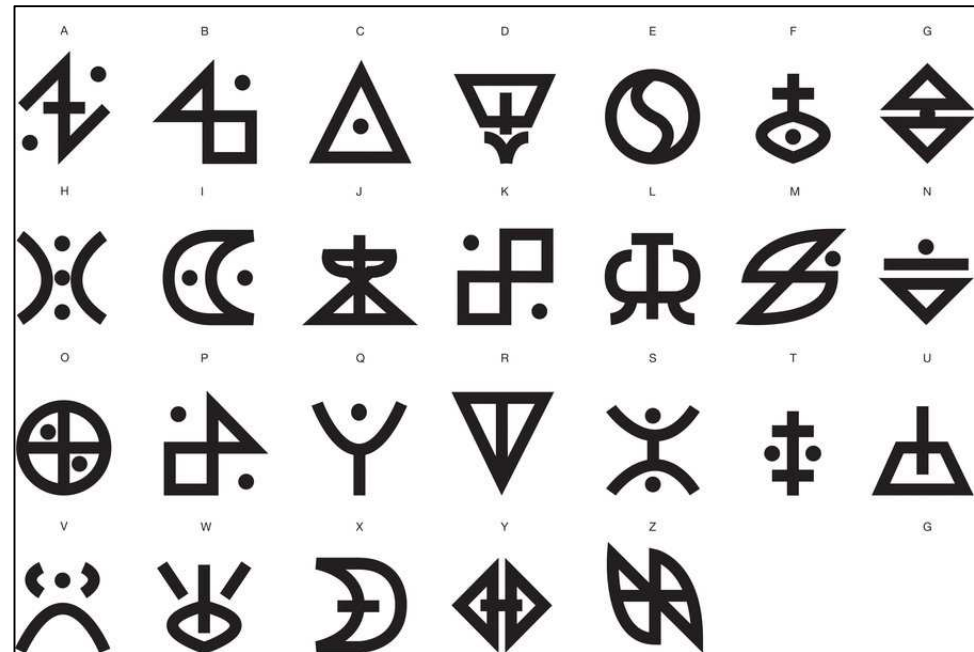



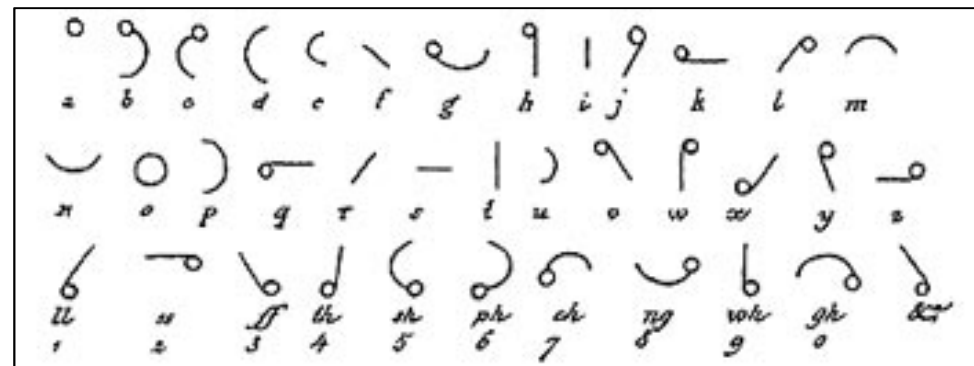













































# LUCAS ALPHABET



## EBCDIC

	0	1	2	3	4	5	6	7	8	9	A	B	C	D	E	F
40			â	ã	à	á	ã	â	ç	ñ	[	.	<	(	+	!
50	&	é	ê	ë	è	í	î	ï	ì	ß	]	\$	*	)	:	^
60	-	/	Â	Ã	À	Á	Ã	Ä	Ç	Ñ	!	.	%	_	>	?
70	ø	É	Ê	Ë	È	Í	Î	Ï	Ì	·	:	#	@	'	=	"
80	ø	a	b	c	d	e	f	g	h	i	«	»	ø	ý	p	±
90	°	j	k	l	m	n	o	p	q	r	°	°	æ	.	Æ	¤
A0	µ	~	s	t	u	v	w	x	y	z	ı	ı	Đ	Ÿ	ƒ	®
B0	¢	£	¥	·	©	§	¶	¼	½	¾	¬		-	-	'	x
C0	{	A	B	C	D	E	F	G	H	I		ô	ö	ò	ó	õ
D0	}	J	K	L	M	N	O	P	Q	R	¹	û	ü	ù	ú	ÿ
E0	\	÷	S	T	U	V	W	X	Y	Z	²	Ô	Ö	Ò	Ó	Õ
F0	0	1	2	3	4	5	6	7	8	9	³	Û	Ü	Ù	Ú	

## THE AUREBESH

								
Aurek (a)	Besh (b)	Cresh (c)	Dorn (d)	Esk (e)	Forn (f)	Grek (g)	Herf (h)	Isk (i)
								
Jenth (j)	Krill (k)	Leth (l)	Mern (m)	Nern (n)	Osk (o)	Peth (p)	Qek (q)	Resh (r)
								
Senth (s)	Trill (t)	Usk (u)	Vev (v)	Wesk (w)	Xesh (x)	Yirt (y)	Zerek (z)	Cherek (ch)
								
Enth (ae)	Onith (eo)	Krenth (kh)	Nen (ng)	Orenth (oo)	Shen (sh)	Thesh (th)	(.)	(.)
								
(?)	(!)	(:)	(;)	(-)	(")	(")	(')	(')
								
((	())	(/)	(Credits sign)					

Note: Horizontal lines are provided to show position of marks relative to top edge and baseline of letters.

## MUZIEKNOTEN

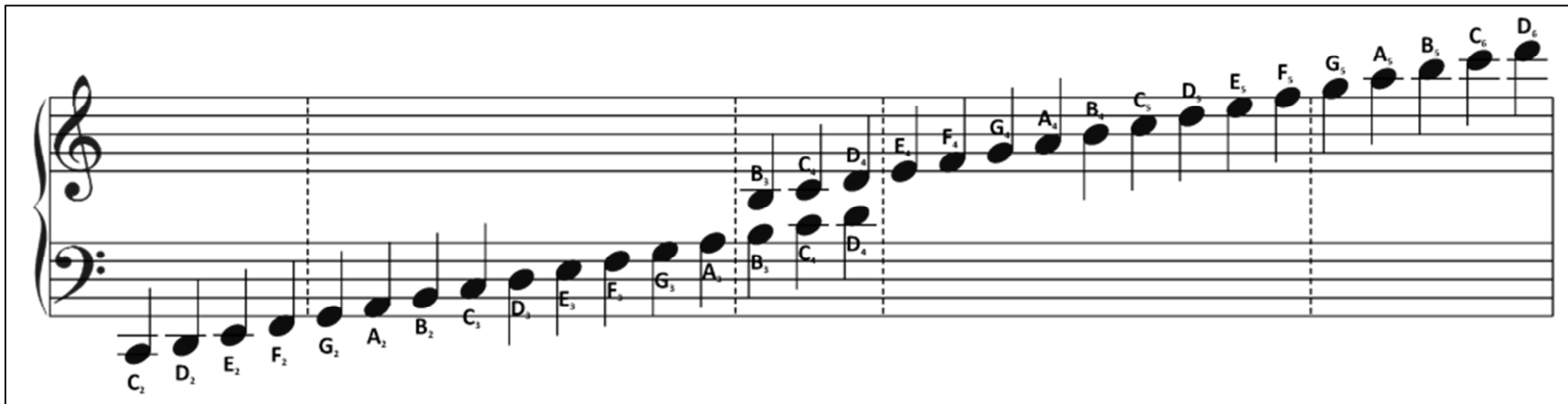

Musical notation showing a scale of notes from C<sub>2</sub> to D<sub>6</sub> on a grand staff. The notes are labeled with their respective letter and octave numbers.

### DAGGER CODE

a	b	c	d	e	f	g	h	i	j	k	l	m	n
o	p	q	r	s	t	u	v	w	x	y	z	*	1

### HVD

A	B	C	D	E	F	G	H
I	L	M	N	O	P	R	S
T	U	V	W	Y	Z	D	O
,	.						

### FANTASIA ALFABET (GERONIMO STILTON)



### MOON ALFABET

Letters										
a	b	c	d	e	f	g	h	i	j	
	but	can	do	every	from	go	have		just	
k	l	m	n	o	p	q	r	s	t	
know	like	more	not		people	quite	rather	some	that	
u	v	w	x	y	z	wh	ch			
	very	was	it	you		which	child			
Numerals										
numeral sign	1	2	3	4	5	6	7	8	9	0

### BIRDS ON A WIRE

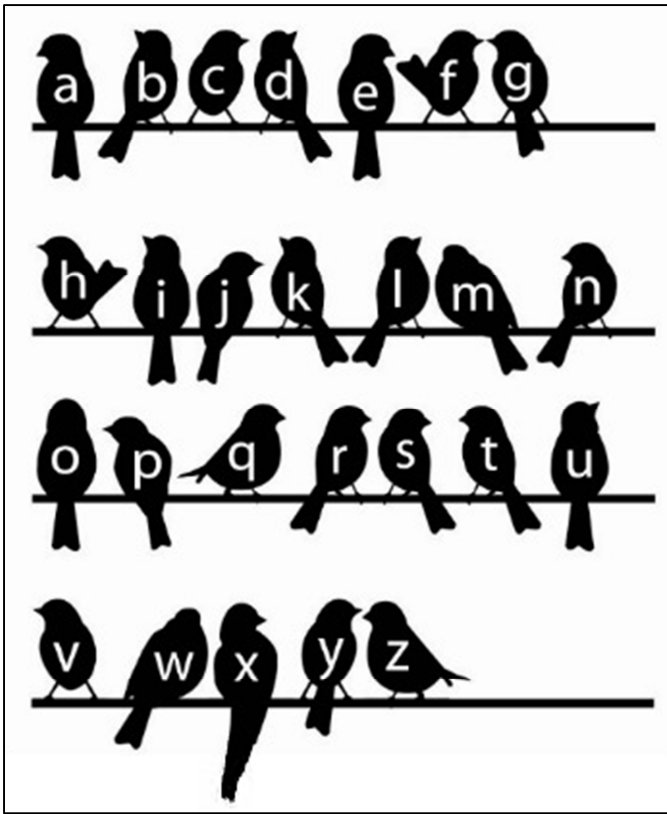

### ATH ALPHABET

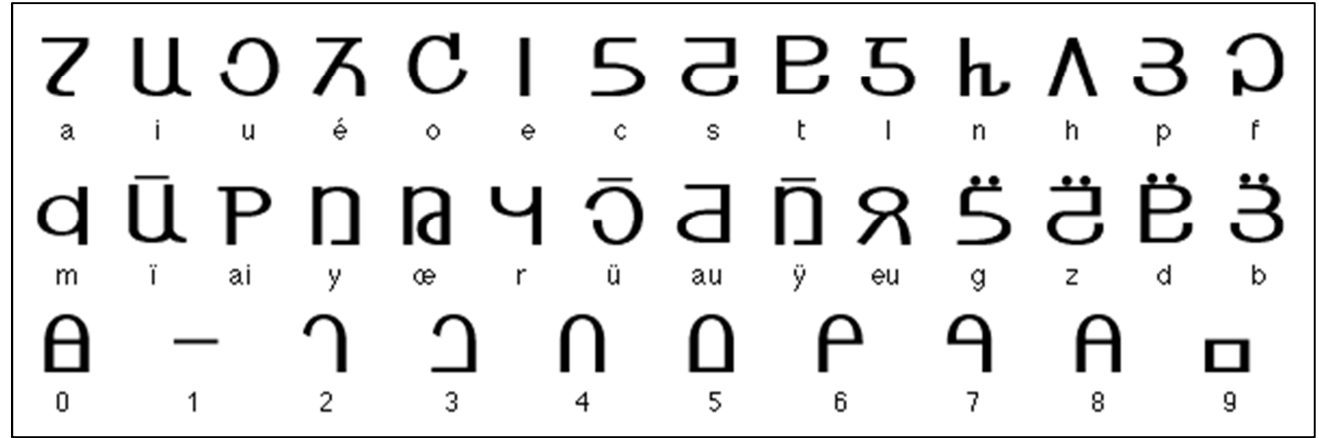

### MAGICODE

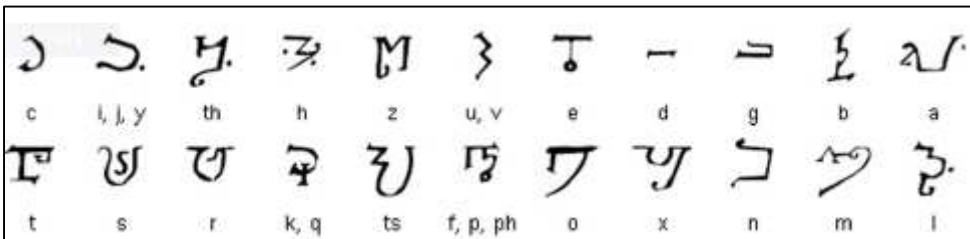

### FUTURAMA CODE



TIMES NEW VIOZIAN

X	x	a	a	Ψ	φ	n	n
V	γ	b	b	P	p	o	o, o
M	m	c	k	P	ϕ	p	p
Q	q	d	d	Λ	λ	q	k, kw
Y	υ	e	ε	W	w	r	r
X	s	f	f	O	o	s	s
d	d	g	g	Γ	c	t	t
b	b	h	x	Z	Z	u	u, w
I	ι	i	i, j	Λ	λ	v	v
Σ	ε	y	i, j	И	ω	w	w
L	l	k	k	Γ	Γ	x	f
Z	z	l	l	Φ	φ	an	an
h	h	m	m	Δ	d	z	δ

VIOZIAN

A	Zz	Oo	N	zz → z̄
B	Γγ	Ii	O	u → ū
C	Σε	bb	P	
D	Δd	Qq	Q	i!
E	Pp	Ll	R	↑?
F	Pc	Zz	S	
G	A <sub>1</sub>	ϕϕ	T	
H	Иω	Yy	U	
I	Xx	Vγ	V	
J	Ψφ	Mm	W	
K	ϕϕ	Σs	X	
L	Λλ	φφ	Y	
M	Ww	d d	Z	

LETTER-CIJFER-CIJFER-LETTER CODE

a	b	c	d	e	f	g	h	i	j	k	l	m	n	o	p	q	r	s	t	u	v	w	x	y	z
1	2	3	4	5	6	7	8	9	10	11	12	13	13	12	11	10	9	8	7	6	5	4	3	2	1

## KHAROSTHIL NUMBERS

I	II	III	X	IX	II X	XX	?
1	2	3	4	5	6	8	10
3	33	333	3333	∧I	∩II		
20	50	60	70	100	200		

## QUIK SCRIPT

Pipe 1	Bob 2	Tut 3	Deed 4	Kick 5	Gig 6	Thoth 7	Thither 8	Fife 9	Valve 10	Sis 11
Zoos 12	Shush 13	Zhivago 14	Church 15	Judge 16	Yo-yo 17	Win-win 18	Ha-ha 19	Whitewheat 20	Inkling 21	Mime 22
Nun 23	Loll 24	Roar 25	If 26	Eat 27	Ed 28	Age 29	Ash 30	Ice 31		
Ah 32	Awl 33	On 34	Oil 35	Ado 36	Out 37	Oak 38	Wool 39	Ooze 40		

## THE DSCRIPT ALPHABET

<b>A</b>	<b>B</b>	<b>C</b>	<b>D</b>	<b>E</b>	<b>F</b>		
<b>G</b>	<b>H</b>	<b>I</b>	<b>J</b>	<b>K</b>	<b>L</b>		
<b>M</b>	<b>N</b>	<b>O</b>	<b>P</b>	<b>Q</b>	<b>R</b>		
<b>S</b>	<b>T</b>	<b>U</b>	<b>V</b>	<b>W</b>	<b>X</b>		
<b>Y</b>	<b>Z</b>						
<b>CH</b>	<b>SH</b>	<b>ST</b>	<b>TH</b>	<b>TS</b>	<b>QU</b>	<b>ION</b>	<b>NG</b>

# MINECRAFT

!	"	#	\$	%	&	'	(	)	*	+	,
-	...	/	0	1	2	3	4	5	6	7	8
9	:	;	<	=	>	?	@	A	B	C	D
E	F	G	H	I	J	K	L	M	N	O	P
Q	R	S	T	U	V	W	X	Y	Z	[	\
]	^	_	`	a	b	c	d	e	f	g	h
i	j	k	l	m	n	o	p	q	r	s	t
u	v	w	x	y	z	{		}	~	ı	ş

# RAUME CODE

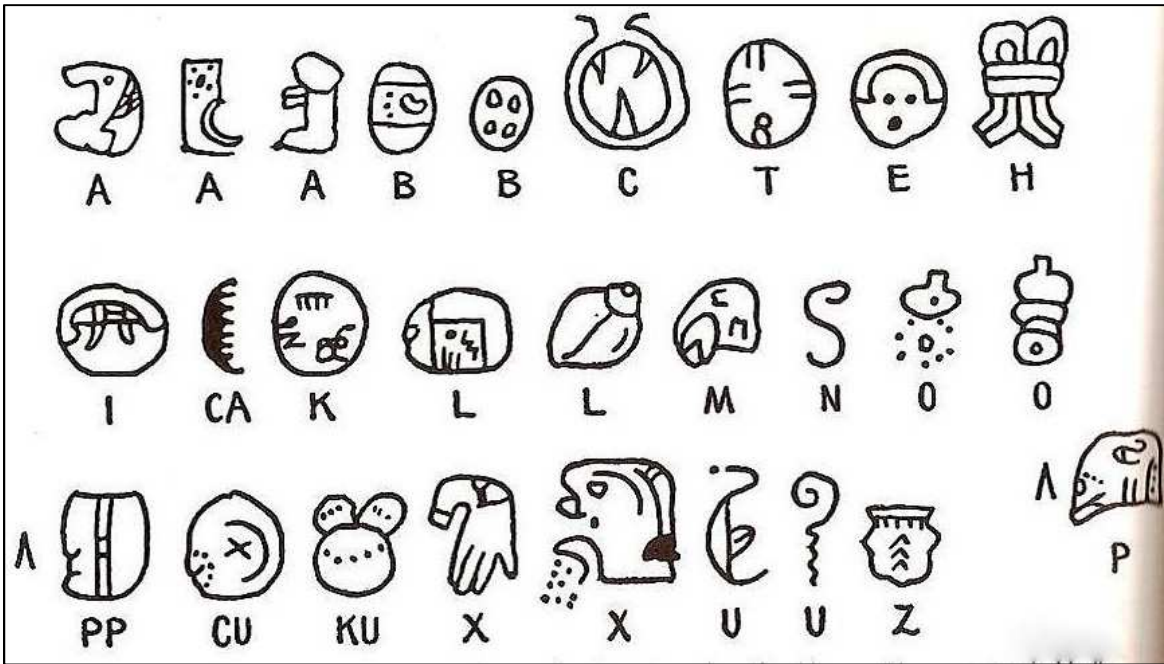

# T 8

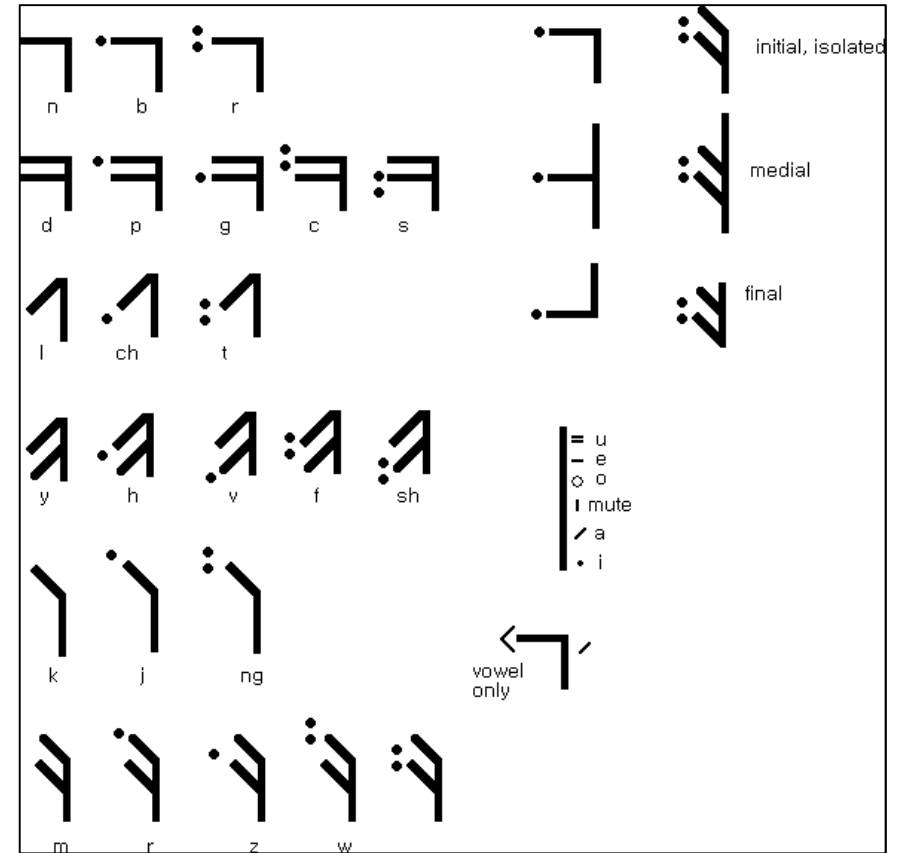

# NICTOGRAPH ALPHABET

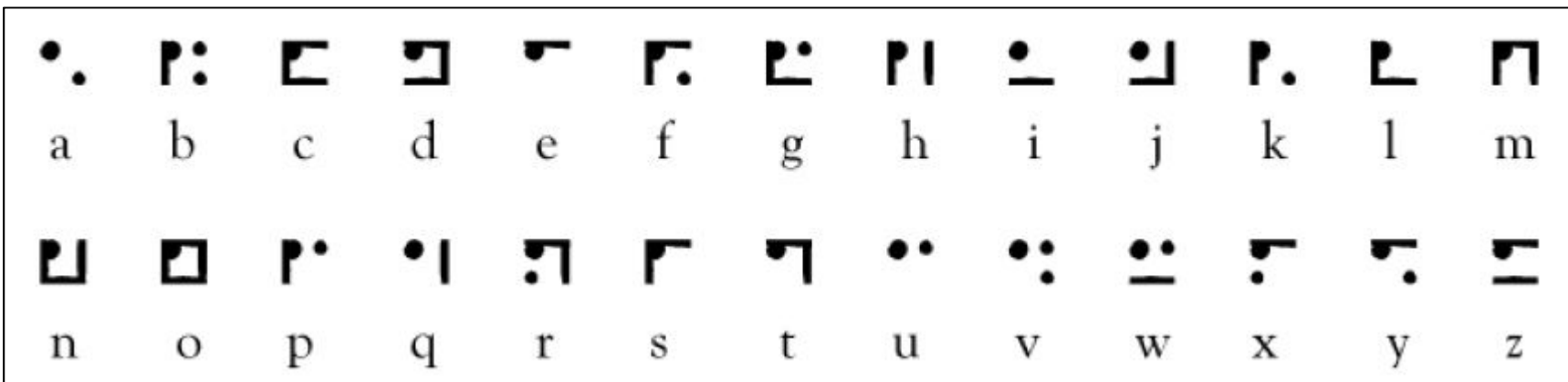



# GALLIFREYAN

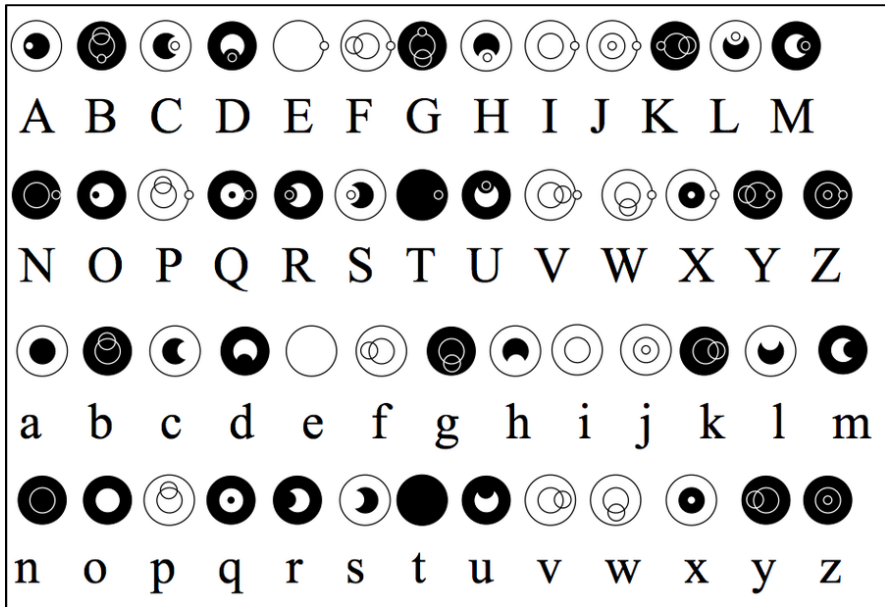

# GALLIFREYAN ALPHABET

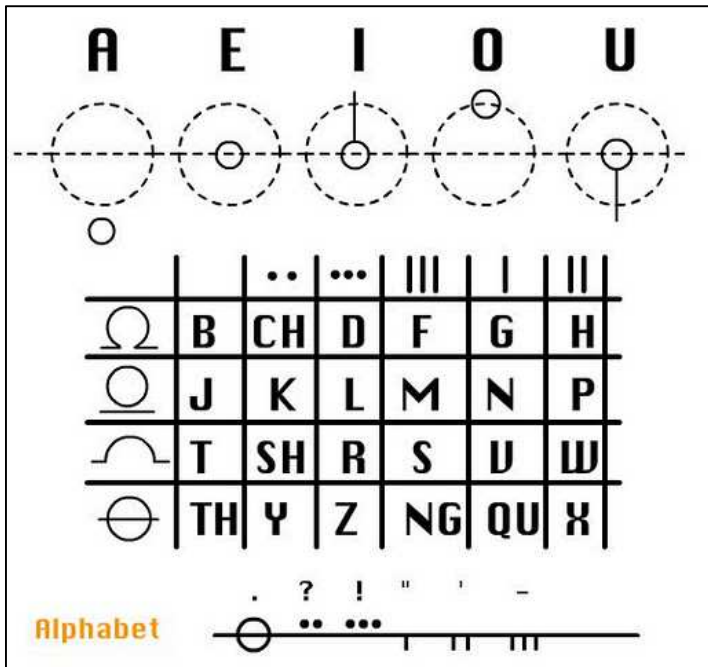

# GALLIFREAN ALPHABET

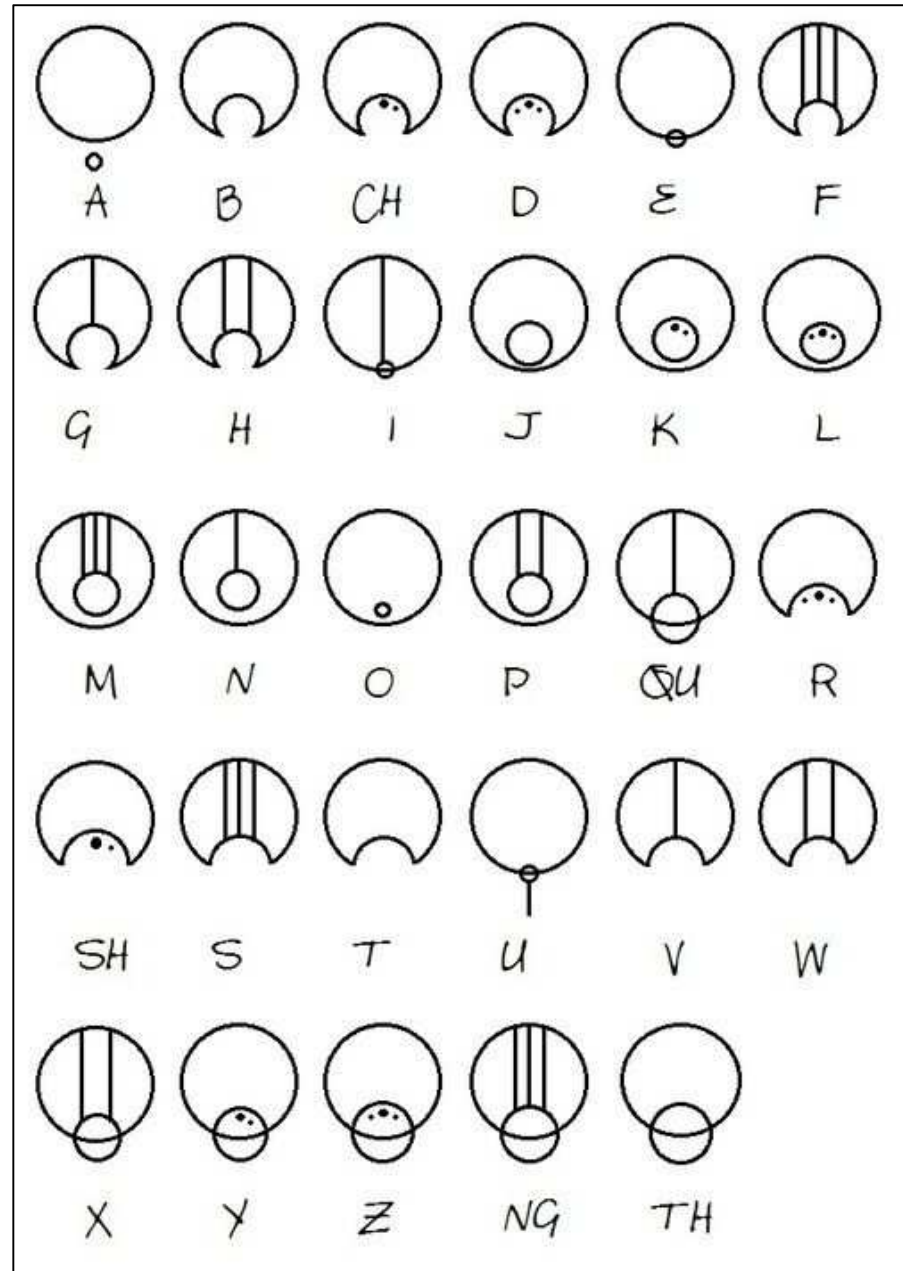

THEBAN ALPHABET  
THEBAN SCRIPT  
INDISCH TELLEN  
BRAHMI TELLEN  
HIERATISCH TELLEN  
GRIEKS TELLEN  
MOBIELTJE  
PC TOETSEN  
PC TOETSEN AMERIKAANS  
ZAMORISCHE GETALLEN  
HEBREEUWS ALFABET  
HEBREEUWSE CIJFERS  
BOOM CODE  
HB3D  
NEW ZEALAND BRANDING SYSTEM  
FEZ CODE  
6FEBRUARISCHRIFT  
COORGI COX ALPHABET  
ANGLE BRANDING SYSTEM  
TEK BIN  
POOL BALLEEN  
VIOZIAANS  
THE DANCING MEN  
DANCING MAN (SHERLOCK HOLMES)  
ERLKONINGSCHRIFT  
PIPELINE CODE  
JAPANS TELLEN

ROMEINSE GETALLEN  
HANGEUL ALPHABET  
KOREAN ALPHABET  
GLAGOLITISCH TELLEN  
GLAGOLITISCH ALPHABET  
HENOCHISCH CODE  
POLYBIUS (5 und 6)  
SPINTYPE  
LEETSPEAK  
KENNY CODE  
GEBITSCODE  
TENWARE CIJFERS  
BAUDOT  
DECABIT  
TOMTOM  
BACKSLASH  
ARCADIAN CODE  
KLOK ALFABET  
BALLET CODE  
SEMAPHORE/CLOCK ALPHABET  
TIFINAGH  
MATRIXCODE  
ATBASH (HEBREW) CIPHER  
BACONIAN CIPHER  
MASON CIPHERS  
CAESAR  
ATBASH

ANCIENT BERBER  
URDU CIJFERS  
SANSKRIT CIJFERS  
GLAGOLICA  
TRAUMANIAANS  
DRIEHOEKJES CODE  
WEBSCHRIFT  
CODIGO ALFABET  
LUCAS ALPHABET  
EBCDIC  
THE AUREBESH  
MUZIEKNOTEN  
DAGGER CODE  
HVD  
FANTASIA ALFABET  
GERONIMO STILTON  
MOON ALFABET  
BIRDS ON A WIRE  
ATH ALPHABET  
FUTURAMA CODE  
MAGICODE  
TIMES NEW VIOZIAN  
VIOZIAN  
LETTER-CIJFER-CIJFER  
KHAROSTHIL NUMBERS  
THE DSCRIPT ALPHABET  
QUIK SCRIPT

**MINECRAFT**

**RAUME CODE**

**T 8**

**NICTOGRAPH ALPHABET**

**GALLIFREYAN**

**GALLIFREAN ALPHABET**

**GALLIFREYAN ALPHABET**

# MIJN CODEBOEK 3.1

## deel 4



# SOCCER / VOETBAL

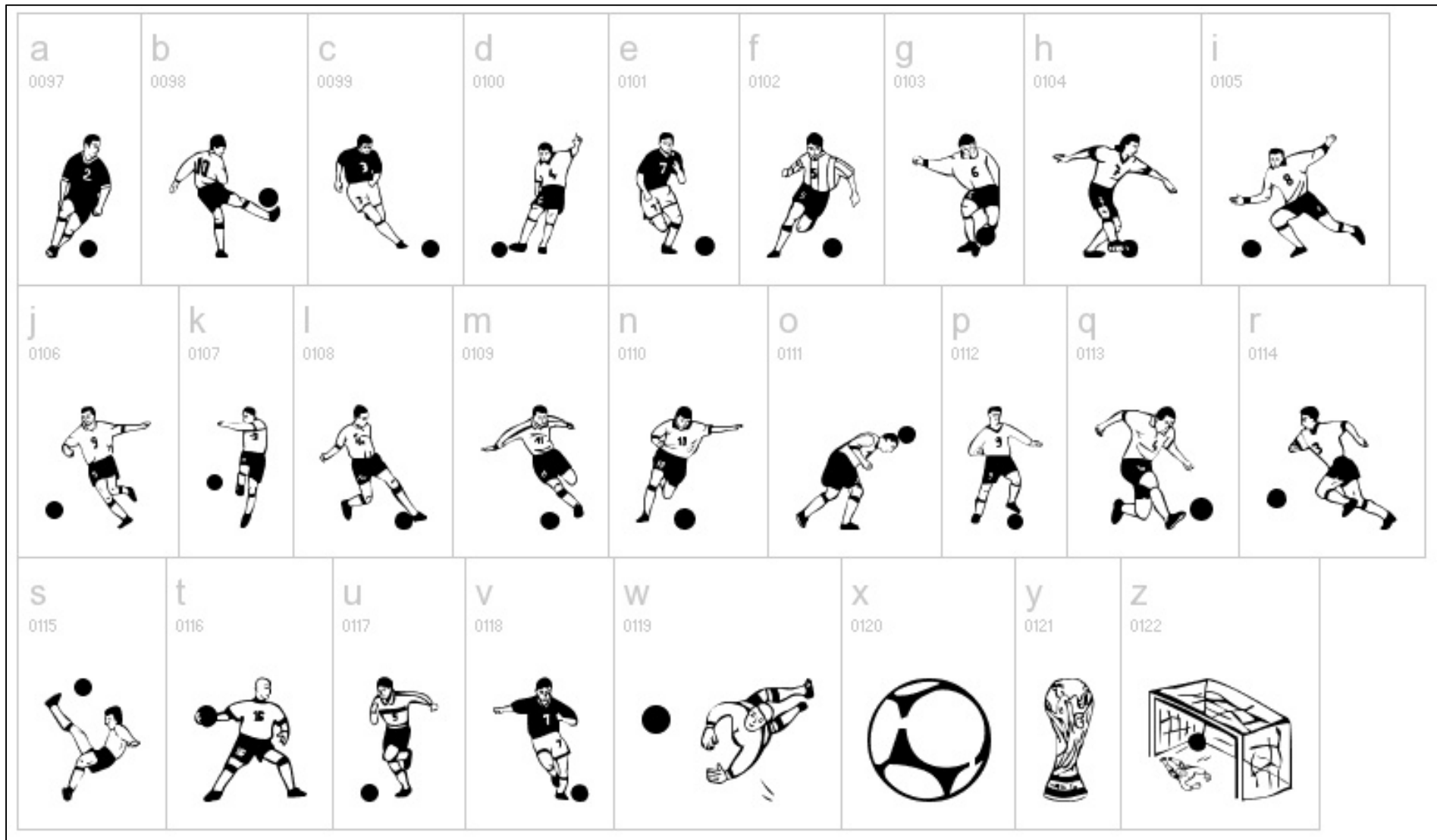

## DOTSIE

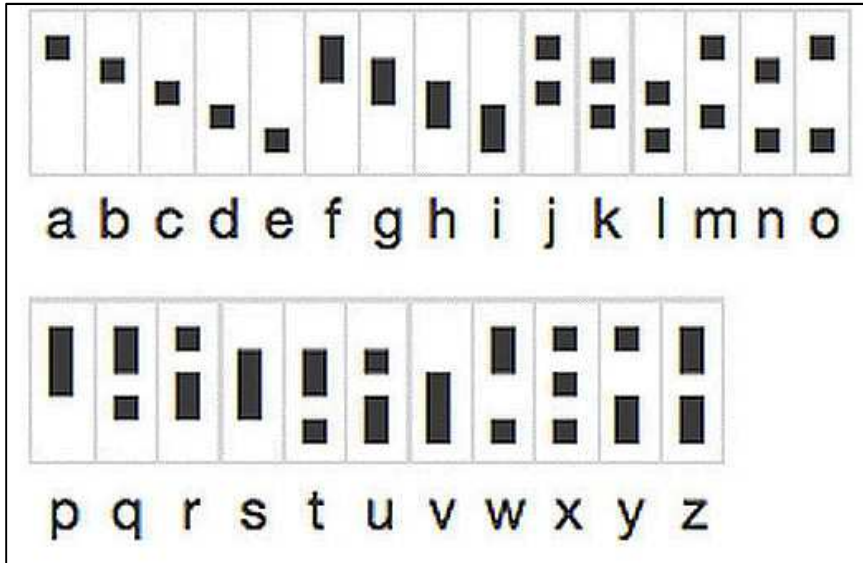

## MOLENTAAL

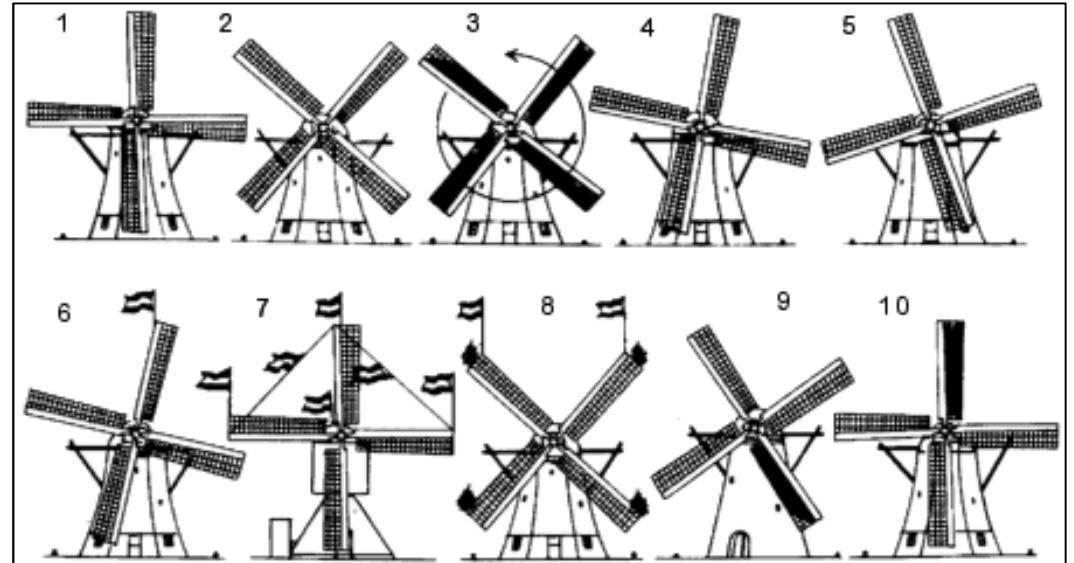

## OGHAM

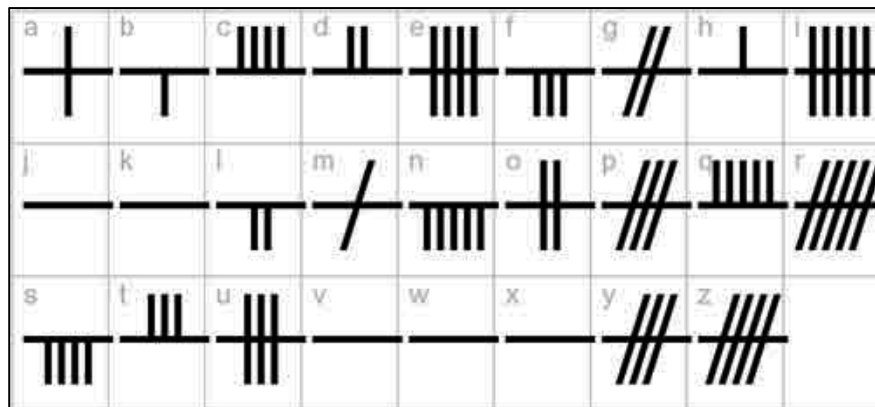

## OGHAM 2

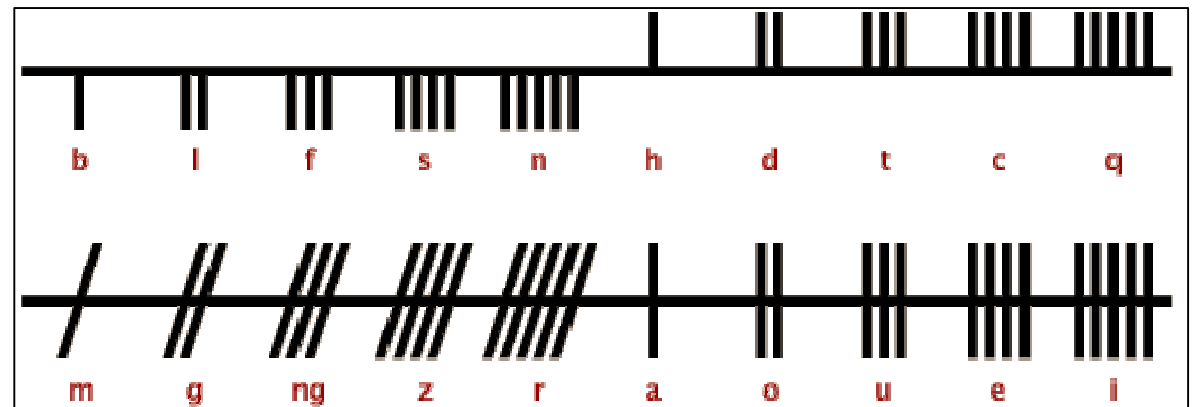

### TIFINAG (VIKING) ALPHABET

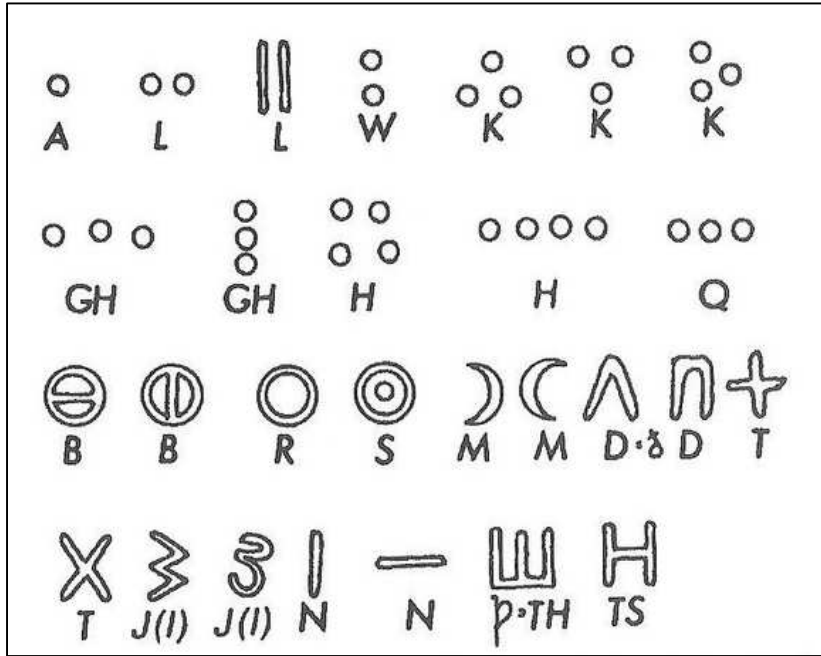

### SHADOW

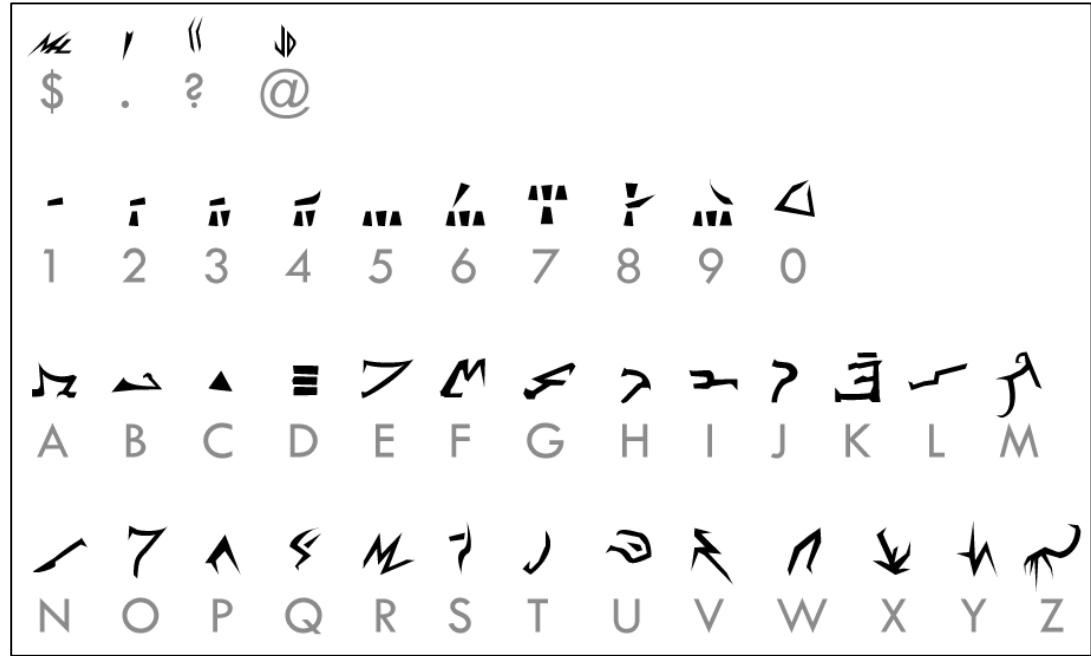

### AETHERIAN SCRIPT



### SHADOWKAN

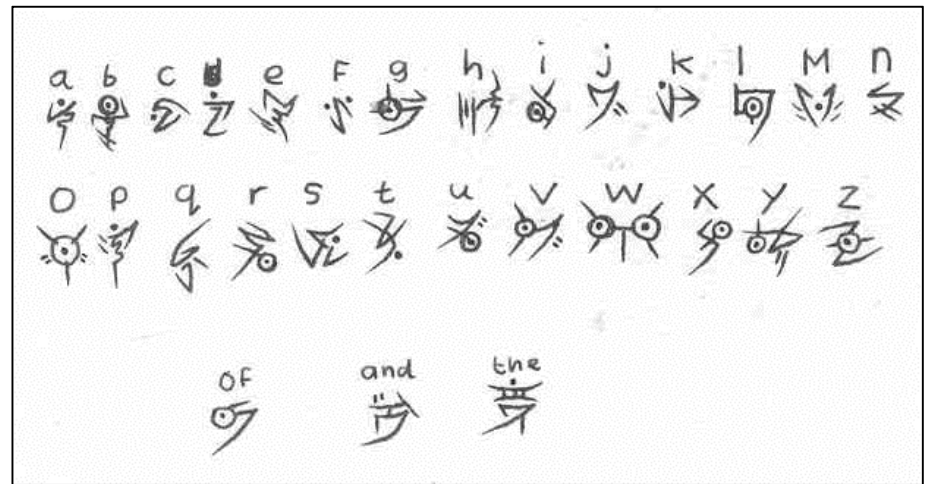

NOXILO

A	B	C	D	E	F	G	H	I	J	K	L	M
ʌ	ɣ	ʒ	ʦ	e	o	ɲ	ɥ	ʁ	ʁ	ʁ	ʁ	ʁ
N	O	P	Q	R	S	T	U	V	W	X	Y	Z
θ	o	ɣ	ʁ	p	s	t	u	v	w	x	y	ʒ
y	n											
y	↓											
AI	EI	AA	II	UU	EE	OO						
ʌ	o	ʁ	ɥ	u	e	o						
yA	yU	yE	yO									
̄	̄	̄	̄									
yAA	yUU	yEE	yOO	-W	-O	-L	-E	-Q				
̃	̃	̃	̄	ʁ	o	p	ʁ	ʁ				

SPECIALE TEKENS

1=!	6=&
2="	7=/
3=§	8=(
4=\$	9=)
5=%	0==

A	B	C	D	E	F	G	
H	I	J	K	L	M	N	
O	P	Q	R	S	T	U	
V	W	X	Y	Z			
/	∟	↑	↘	▽	◇	»	«
.	,	!	?	'	-	“	”
∕	∕	∕	∕				
:	;	(	)				

ARABISCH TELLEN































0	1	2	3	4	5	6	7	8	9
•	١	٢	٣	٤	٥	٦	٧	٨	٩





























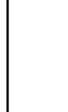



















### SAN LUCA CODE

σ = A	υ = H	Υ = Q
3 = B	χ = I	Δ = R
o = C	ϛ = L	Ϙ = S
ϛ = D	Ϟ = π	□ = T
ϛ = E	Ϟ = Z	^ = U
d = F	Ϟ = O	T = V
ι = G	⊙ = P	↓ = Z

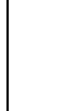
### ATLANTEAN ALPHABET

									
a	b	c	ch	d	e	f	g	h	i
									
j	k	l	m	n	o	p	q	r	s
									
sh	t	th	u	v	w	x	y	z	z

### ANCIENT AND WRAITH ALPHABETH

A	B	C	D	E	F	G	H	I	J	K	L	M	N	O	P	Q	R	S	T	U	V	W	X	Y	Z
																									
																									

PLANET

POSTNET

Value	Encoding
1	
2	
3	
4	
5	
6	
7	
8	
9	
0	

Value	Encoding
1	
2	
3	
4	
5	
6	
7	
8	
9	
0	

A		H		O		V	
B		I		P		W	
C		J		Q		X	
D		K		R		Y	
E		L		S		Z	
F		M		T			
G		N		U			<b>SPACE</b>

KEIHAN

VESPERIA ALPHABET

A	B	C	D	E	F	G	H	I	J	K	L	M
N	O	P	Q	R	S	T	U	V	W	X	Y	Z

a	b	c	d	e	f	g	h	i	j	k	l	m
n	o	p	q	r	s	t	u	v	w	x	y	z
1	2	3	4	5	6	7	8	9	0			

 Original alphabet from Tales of Vesperia, copyright Namco Bandai  
 Render by HalcyonAdvent on deviantART - original source from Abyssal Chronicles

## GENREICH

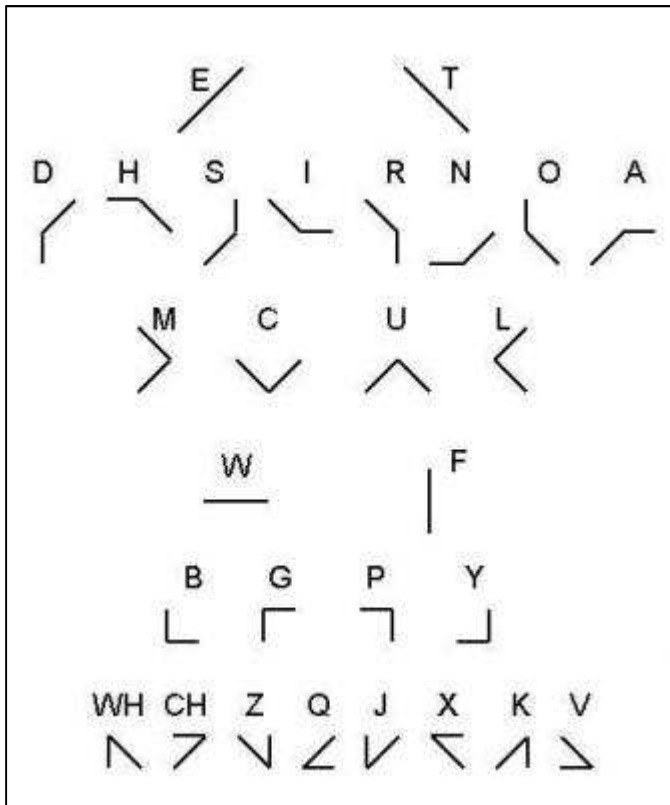

## SPECIALE TEKENS ARABISCH

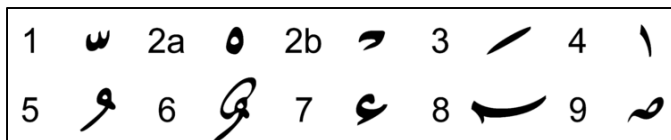

## FONIC LANGUAGE

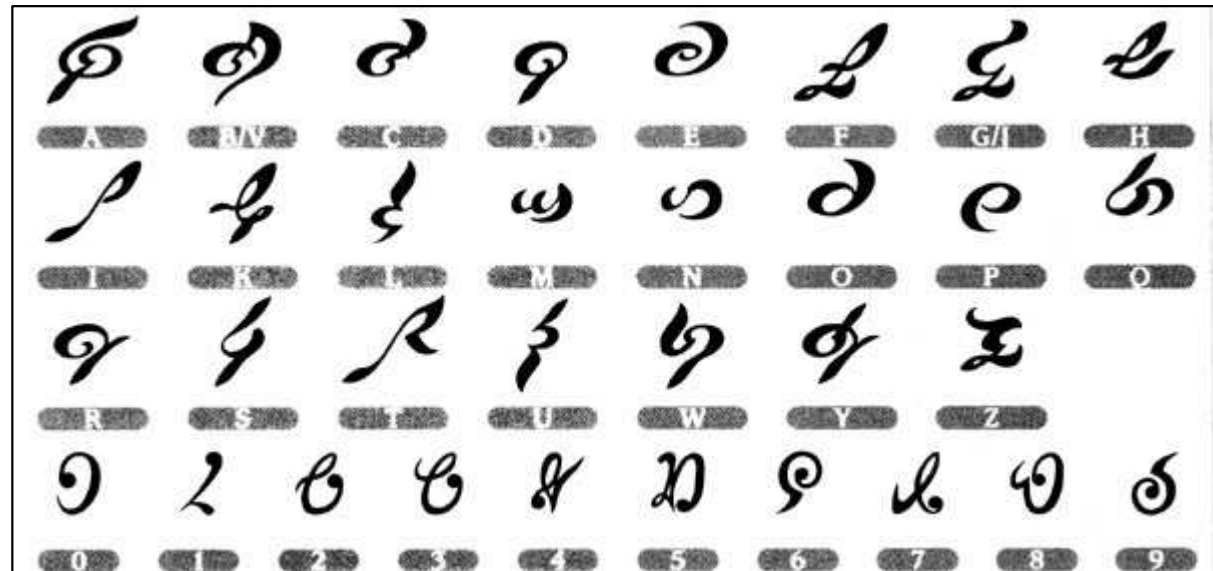

## DINGBATCAVE

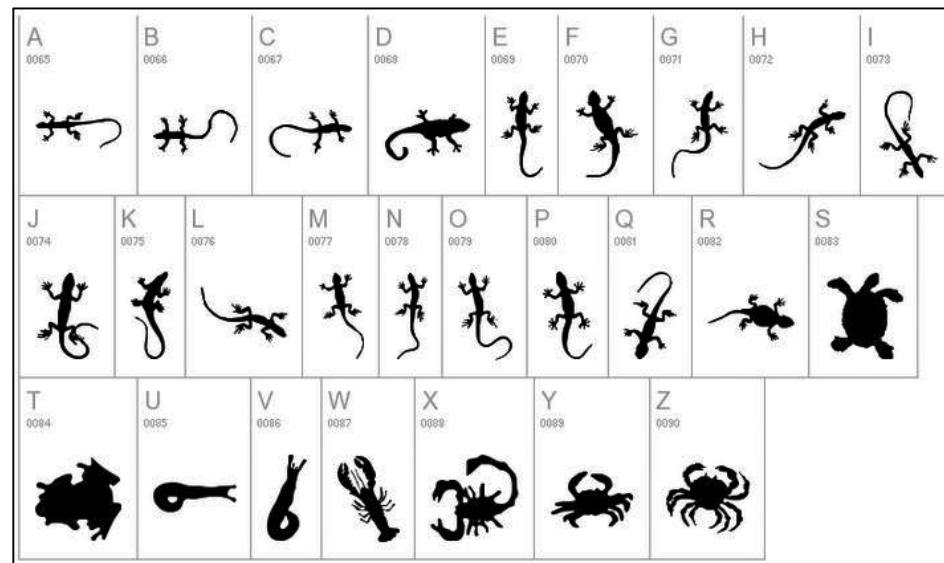

# EMOTICONS

A	B	C	D	E	F	G	H	I	J
K	L	M	N	O	P	Q	R	S	T
U	V	W	X	Y	Z				
a	b	c	d	e	f	g	h	i	j
k	l	m	n	o	p	q	r	t	u
v	w	x	y	z					
0	1	2	3	4	5	6	7	8	9
\$	¢	□	£	¥	¤	+	-	*	/
÷	=	%	□	"	'	#	@	&	~
(	)	•	◉	;	:	¿	?	¡	!
`		{	}	<	>	[	]	^	¶

# FACE - IT

A	B	C	D	E	F	G	H	I	J
K	L	M	N	O	P	Q	R	S	T
U	V	W	X	Y	Z				
a	b	c	d	e	f	g	h	i	j
k	l	m	n	o	p	q	r	t	u
v	w	x	y	z					
0	1	2	3	4	5	6	7	8	9

# HUMEUR

A	B	C	D	E	F	G	H	I	J
K	L	M	N	O	P	Q	R	S	T
U	V	W	X	Y	Z				
a	b	c	d	e	f	g	h	i	j
k	l	m	n	o	p	q	r	t	u
v	w	x	y	z					
0	1	2	3	4	5	6	7	8	9

# PLAYING CARDS

A	B	C	D	E	F	G	H	I	J
K	L	M	N	O	P	Q	R	S	T
U	V	W	X	Y	Z				
a	b	c	d	e	f	g	h	i	j
k	l	m	n	o	p	q	r	t	u
v	w	x	y	z					
0	1	2	3	4	5	6	7	8	9

# ACCOORDEN

<b>A</b> 	<b>B</b> 	<b>C</b> 	<b>D</b> 	<b>E</b> 	<b>F</b> 	<b>G</b> 	<b>H</b> 	<b>I</b> 	<b>J</b> 
<b>K</b> 	<b>L</b> 	<b>M</b> 	<b>N</b> 	<b>O</b> 	<b>P</b> 	<b>Q</b> 	<b>R</b> 	<b>S</b> 	<b>T</b> 
<b>U</b> 	<b>V</b> 	<b>W</b> 	<b>X</b> 	<b>Y</b> 	<b>Z</b> 				
<b>a</b> 	<b>b</b> 	<b>c</b> 	<b>d</b> 	<b>e</b> 	<b>f</b> 	<b>g</b> 	<b>h</b> 	<b>i</b> 	<b>j</b> 
<b>k</b> 	<b>l</b> 	<b>m</b> 	<b>n</b> 	<b>o</b> 	<b>p</b> 	<b>q</b> 	<b>r</b> 	<b>t</b> 	<b>u</b> 
<b>v</b> 	<b>w</b> 	<b>x</b> 	<b>y</b> 	<b>z</b> 					
<b>0</b> 	<b>1</b> 	<b>2</b> 	<b>3</b> 	<b>4</b> 	<b>5</b> 	<b>6</b> 	<b>7</b> 	<b>8</b> 	<b>9</b> 

**SOCCER / VOETBAL**

**DOTSIE**

**MOLENTAAL**

**OGHAM**

**OGHAM 2**

**TIFINAG (VIKING) ALPHABET**

**SHADOW**

**AETHERIAN SCRIPT**

**SHADOWKAN**

**NOXILO**

**SPECIALE TEKENS**

**ARABISCH TELLEN**

**SAN LUCA CODE**

**ATLANTEAN ALPHABET**

**ANCIENT AND WRAITH ALPHABETH**

**PLANET**

**POSTNET**

**KEIHAN**

**VESPERIA ALPHABET**

**GENREICH**

**FONIC LANGUAGE**

**DINGBATCAVE**

**SPECIALE TEKENS ARABISCH**

**EMOTICONS**

**FACE - IT**

**HUMEUR**

**PLAYING CARDS**

**ACCOORDEN**

# MIJN CODEBOEK 3.1

## deel 5





# KING WEN HEXAGRAM SEQUENCE

Felső trigram	Alkotó	Befogadó	Gerjesztő (Dörgés)	Szél (Fa)	Szakadékos (Víz)	Tűz	Hegy	Tó (Derűs)
Alsó trigram								
Alkotó	 1	 11	 5	 14	 34	 26	 9	 43
Befogadó	 12	 2	 8	 35	 16	 23	 20	 45
Gerjesztő (Dörgés)	 6	 7	 29	 64	 40	 4	 59	 47
Szél (Fa)	 13	 36	 63	 30	 55	 22	 37	 49
Szakadékos (Víz)	 25	 24	 3	 21	 51	 27	 42	 17
Tűz	 33	 15	 39	 56	 62	 52	 53	 31
Hegy	 44	 46	 48	 50	 32	 18	 57	 28
Tó (Derűs)	 10	 19	 60	 38	 54	 41	 61	 58













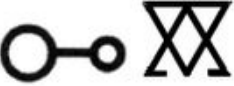

























# CONVENANT

	A		J		S
	B		K		T
	C		L		U
	D		M		V
	E		N		W
	F		O		X
	G		P		Y
	H		Q		Z
	I		R		





























# PROTO SINAITISCH

Letter naam	Proto Sinaitisch	Letter betekenis
'aleph		os
beth		huis
gimmel		werpstok
daleth		deur
he		
waw		haak/pen
zayin		
heth		hek
teth		
yodh		arm/hand
kaph		handpalm
lamedh		prikkel/kromstaf
mem		water
nun		slang
samekh		
'ayin		oog
pe		
tsade		
qoph		
reš		hoofd
šin		
taw		merk(?)

# ALCHEMIE

 Alaun	 Aluminium	 Antimon	 Arsen	 Asche	 Blei
 Borax	 Eisen	 Eisenoxid	 Element	 Erde	 Essig
 Feuer	 Glas	 Gold	 Kadmium	 Kaolin	 Kobalt
 Kochsalz	 Kohle	 Königswasser	 Kupfer	 Luft	 Magnesiumoxid
 Nickel	 Platin	 Quecksilber	 Salpeter	 Sand	 Schwefel
 Seife	 Silber	 Talkum	 Tellur	 Wachs	 Wasser
 Wismut	 Zink	 Zinn	 Öl		

# KITTAT

t		i "heat"	7	<p>Note that some consonants combine with w and y to form complex characters:</p> <p>tw </p> <p>dw </p> <p>mw </p> <p>nw </p> <p>tsw </p> <p>dzw </p> <p>ty </p> <p>dy </p> <p>my </p> <p>ny </p> <p>tsy </p> <p>dzy </p>
d		"hit"		
k		ā "hat"	l	
q				
m		u "suit"	y	
n		"soot"		
ts		ū "hut"	˘	
dz				
s		o "toad"	˘	
z				
h		a "ah"	˘	
ch				
j		oi "toy"	˘	
sh				
r/l		ai "buy"	s	
w				
y				

## AIRCRAFT MARSHALLING SIGNALS



## MOTORCYCLE SIGNALS

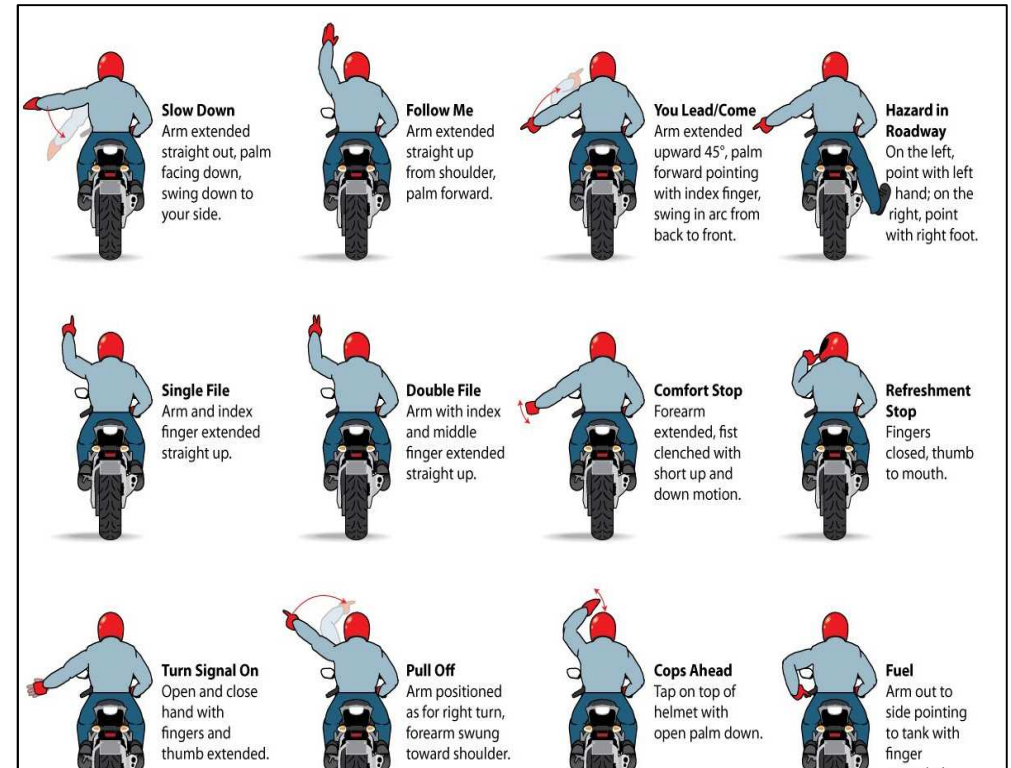

## MOBILE CRANE HAND SIGNALS

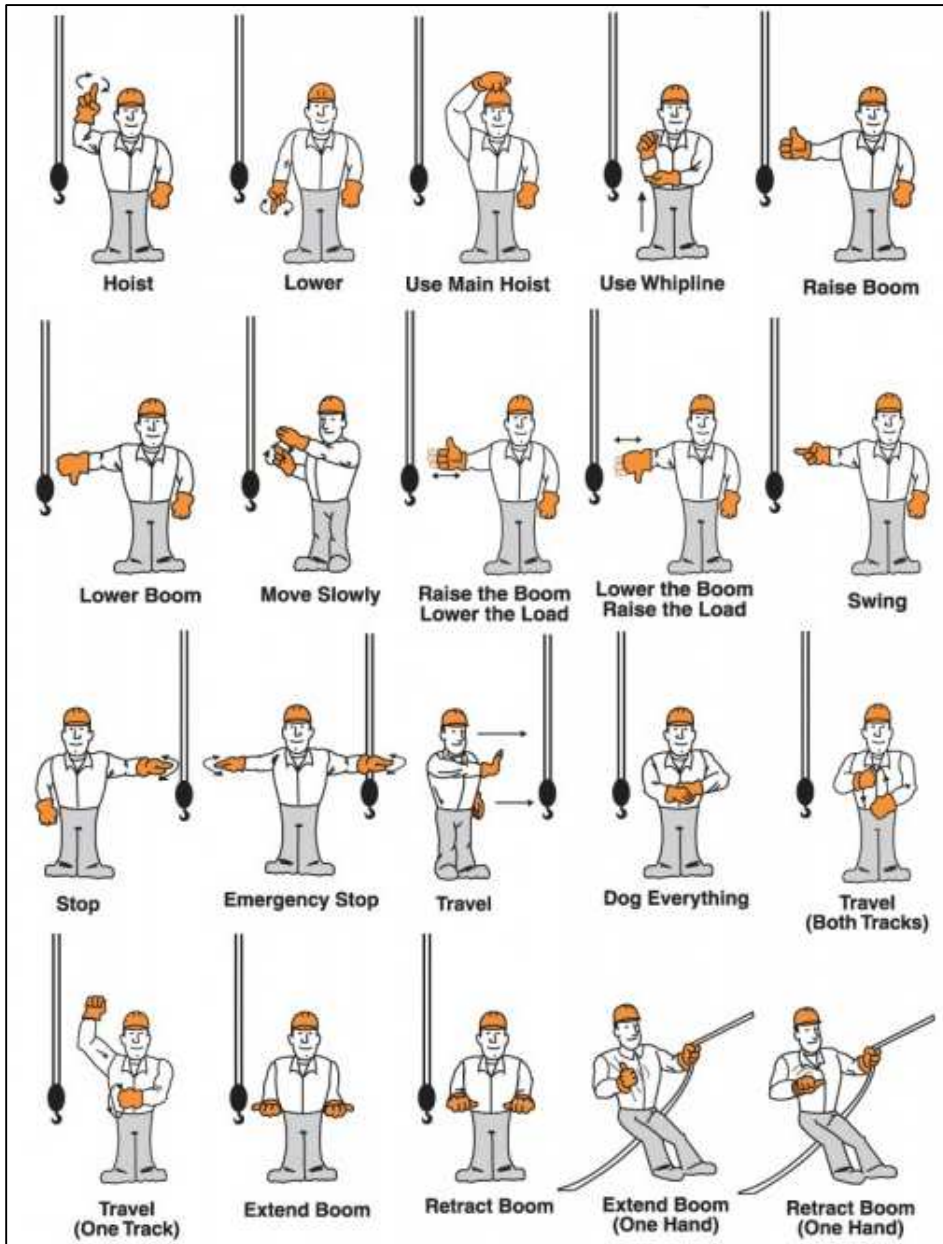

## CRANE SIGNALS

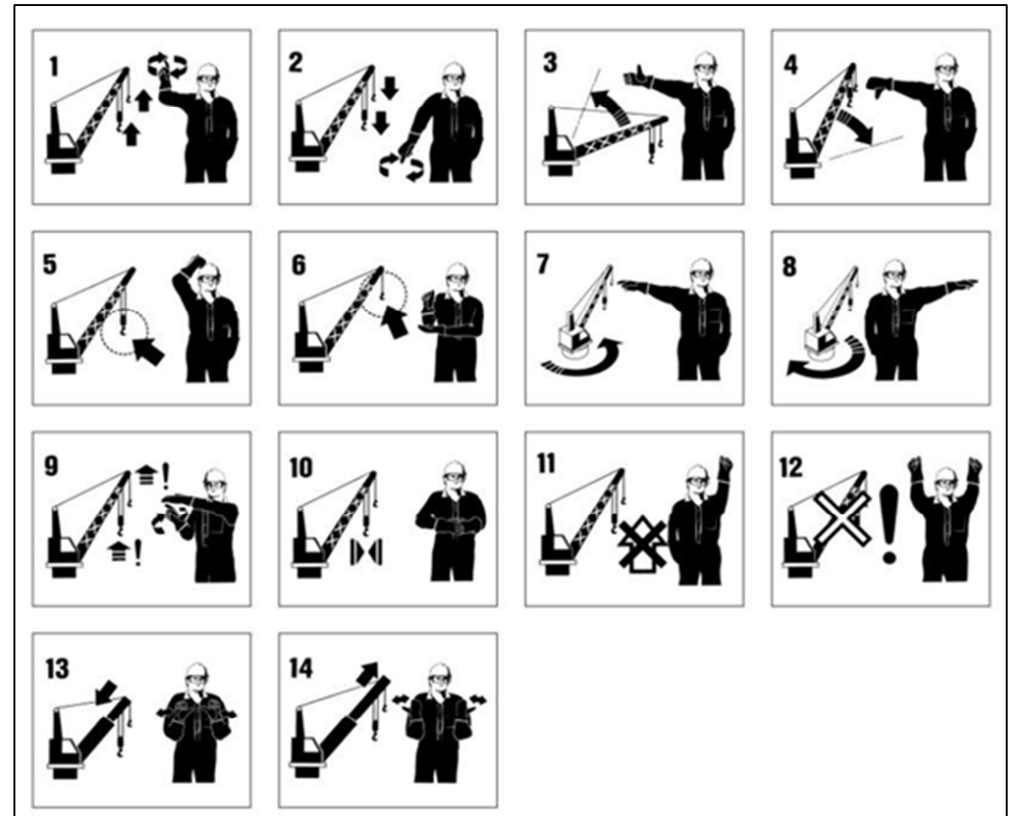

# BASIC MILITARY HAND SIGNALS





































## MILITARY HAND SIGNALS



## ALTITUDE INDICATOR



## SECTION AND PLATOON FIELD SIGNALS

 <p><b>READY TO MOVE</b> Move hand as if cranking car handle.</p>	 <p><b>DEPLOY</b> Arm extended below shoulder level and waved slowly from side to side, hand open. If deployment to either side is wanted, the commander points to the flank concerned after completing the signal.</p>	 <p><b>ADVANCE OR FOLLOW ME</b> Arm swung from rear to front below the shoulder.</p>	 <p><b>HALT/REST</b> Arm raised until the hand is level with the shoulder. Indicate length of halt by fingers. Point to rest area.</p>	 <p><b>GO BACK OR TURN AROUND</b> Hand circled at hip height.</p>	 <p><b>CLOSE OR JOIN ME</b> Hand placed on top of head, elbow square to the right or left, according to which hand is used. Point to RV.</p>	 <p><b>DOUBLE</b> Clenched hand moved up and down between thigh and shoulder.</p>
 <p><b>SLOW DOWN (APC)</b> Arm extended to the side below the shoulder, palm downwards, moved slowly up and down, wrist loose.</p>	 <p><b>LIE DOWN OR DISMOUNT (APC)</b> Two or three slight movements with the open hand towards the ground (palm downwards).</p>	 <p><b>AS YOU WERE, OR SWITCH OFF (APC)</b> Forearm extended downwards, hand open, waved across the body parallel to</p>	 <p><b>ENEMY SEEN OR SUSPECTED</b> Thumb pointed towards the ground from clenched fist.</p>	 <p><b>NO ENEMY IN SIGHT OR ALL CLEAR</b> Thumb pointed upwards from a clenched fist.</p>	 <p><b>LSW GUNNER (GUN GROUP)</b> Clenched fist raised to shoulder height.</p>	 <p><b>SCOUT GROUP</b> Clenched fist with forefinger upright.</p>
 <p><b>FIRE TEAM (RIFLE GROUP)</b> "Victory" sign - first and second fingers extended and open in V, remainder of fist closed.</p>	 <p><b>5mm MORTAR</b> Weapon held vertical. Initial heading of rounds.</p>	 <p><b>LAW/MAW</b> Weapon placed on shoulder and held like a LAW/MAW.</p>	 <p><b>SECTION COMMANDER</b> Two open fingers held against arm to indicate Corporal's stripes.</p>	 <p><b>PLATOON COMMANDER</b> Two open fingers held on shoulder's to indicate Lieutenant's stars.</p>	 <p><b>GIVE COVERING FIRE</b> Weapon brought into aim.</p>	 <p><b>OBSTACLES OR CROSSING OR TRACK JUNCTION</b> Arms crossed. For water obstacle, make waves.</p>
 <p><b>HOUSE OR HUT</b> Hands folded in inverted V to indicate slope of roof.</p>	 <p><b>RECONNAISSANCE</b> Hand held to the eye, as though using a monocular.</p>	 <p><b>ATTACK</b> A chopping movement with edge of hand in direction attack is required.</p>	 <p><b>MOVE UP</b> Fingers spread, arm swung slowly in direction movement is required.</p>	 <p><b>FORM AMBUSH</b> Hand placed over face, followed by pointing to place of ambush.</p>	 <p><b>FREEZE AND LISTEN</b> Hand clogged to ear.</p>	 <p><b>O GROUP</b> Fingers together, moved in conjunction with thumb to indicate person talking.</p>
 <p><b>RIGHT/LEFT FLANKING</b> A curved sweeping movement of the arm in the direction concerned.</p>	 <p><b>FIRE AND MOVEMENT</b> One hand used in a rolling forward action in front of the body.</p>	 <p><b>SPACE OUT</b> Palm of hands held against weapon and moved away several times.</p>	 <p><b>SINGLE FILE</b> One arm fully extended above the head.</p>	 <p><b>STAGGERED FILE</b> Both arms fully extended above the head.</p>	 <p><b>ARROWHEAD</b> Both arms forced backwards or forwards at an angle of 90° each, depending on whether arrow is to the back or forward.</p>	 <p><b>EXTENDED LINE</b> Arms raised to the side level with the ground, indicate which side gun group is to go.</p>

**Field signals give a means of conversing silently. They should be used whenever possible, and should be practised constantly. Before a signal is given the attention of the platoon or section must be attracted. Here are four possible methods:**

1. Single whistle blast (during fire contact only).
2. Snapping forefinger and thumb.
3. Knocking rifle butt with knuckles.
4. Silent whistle.

## FOOTBALL REFEREE SIGNALS

## BASKETBALL REFEREE SIGNALS





## CRICKET UMPIRE HAND SIGNALS

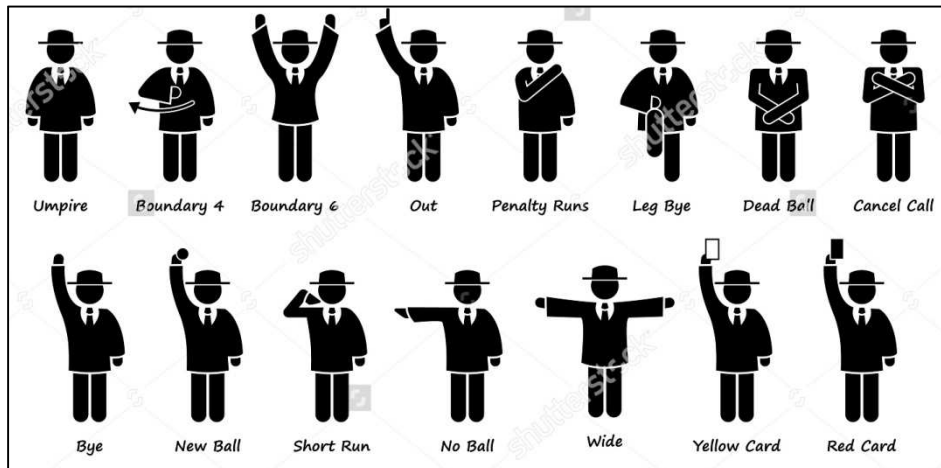

## RED HERRING

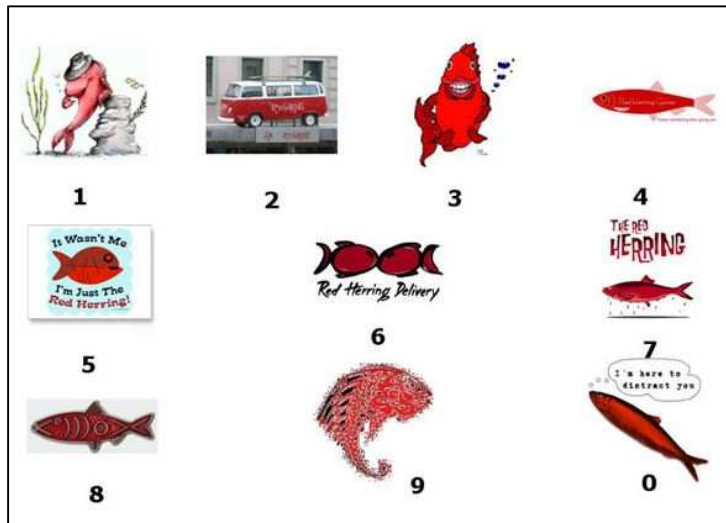

## JURERING TURNEN

[http://www.kngu.nl/uploads/turnen\\_dames/Documenten/2014/Nieuw\\_seizoen\\_2014-2015\\_-\\_wedstrijdreglementen/mailtje\\_janny\\_281214/Oefenstof\\_D4.pdf](http://www.kngu.nl/uploads/turnen_dames/Documenten/2014/Nieuw_seizoen_2014-2015_-_wedstrijdreglementen/mailtje_janny_281214/Oefenstof_D4.pdf)

## VOLLEYBALL SIGNALS (NFHS)

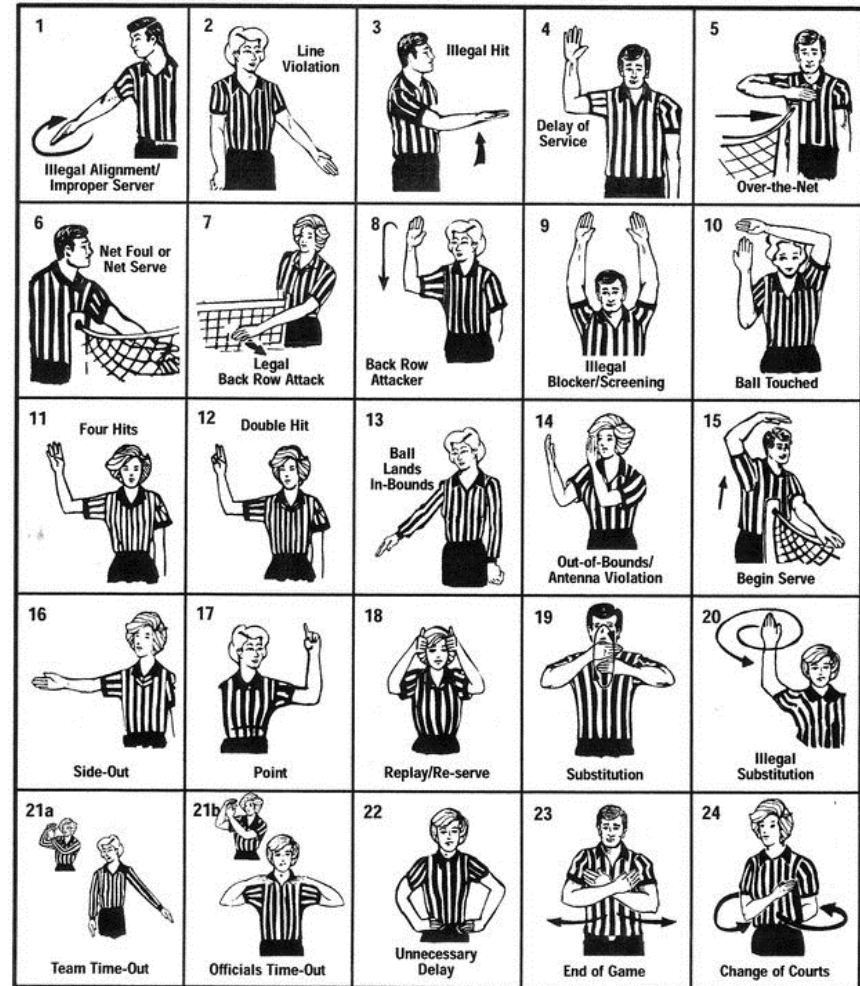

## BROEKENCODE



## BARCODES

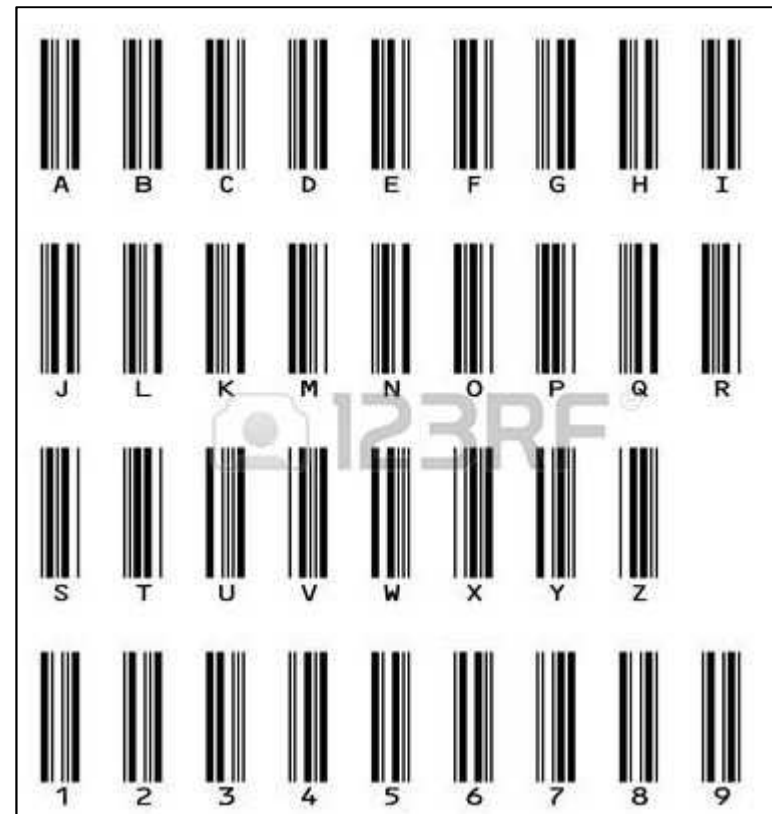



MAYAN



OUDE SYMBOLEN / SMEEDIJZEREN HEK

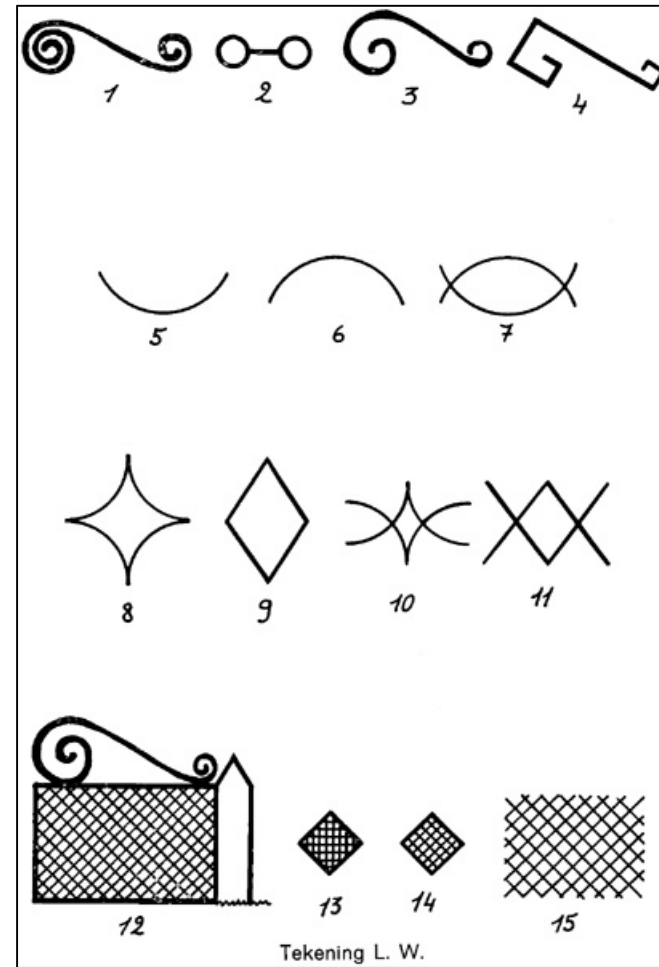

## POKEMON

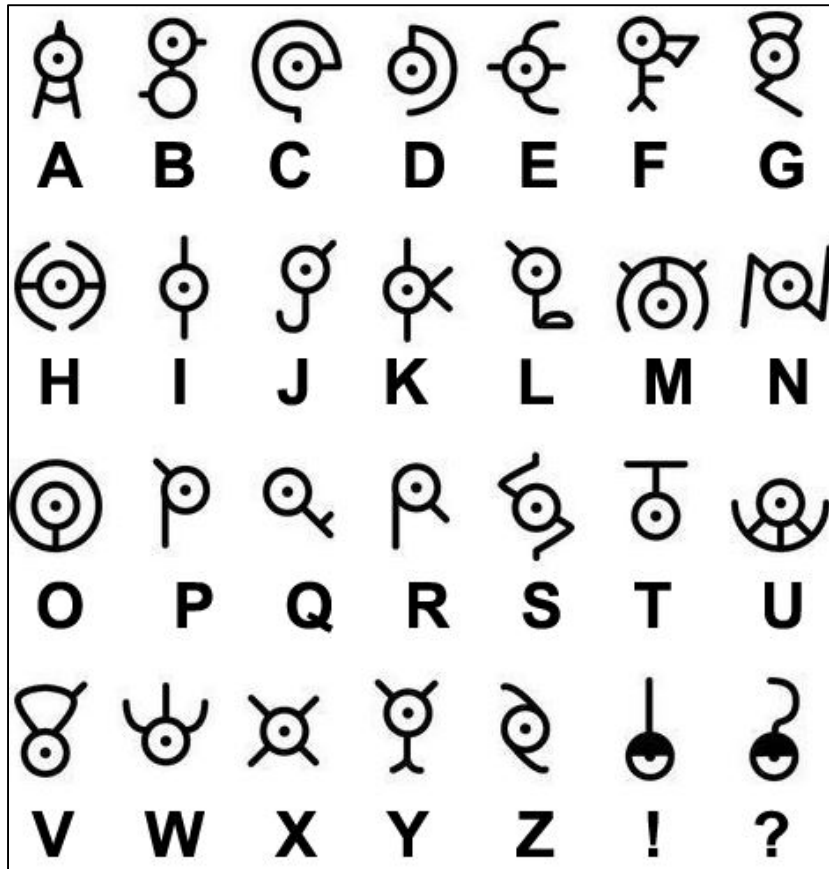

## RIDDERS EN JONKVROUWEN

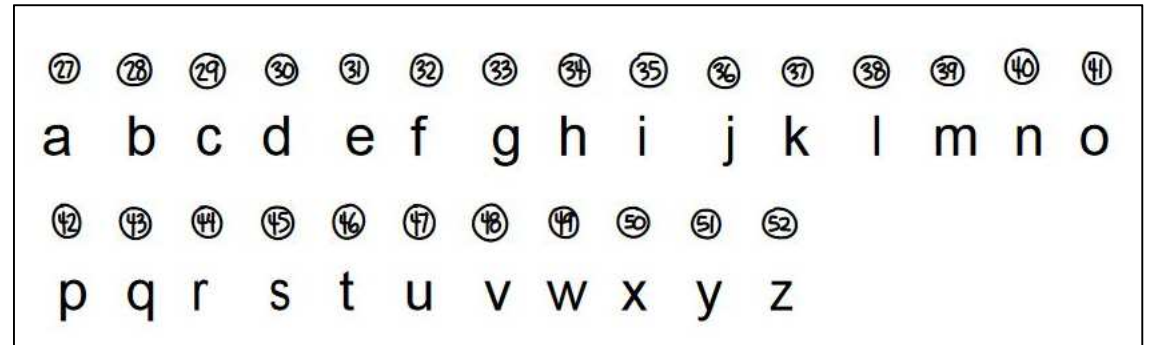

## GEONOSIAN

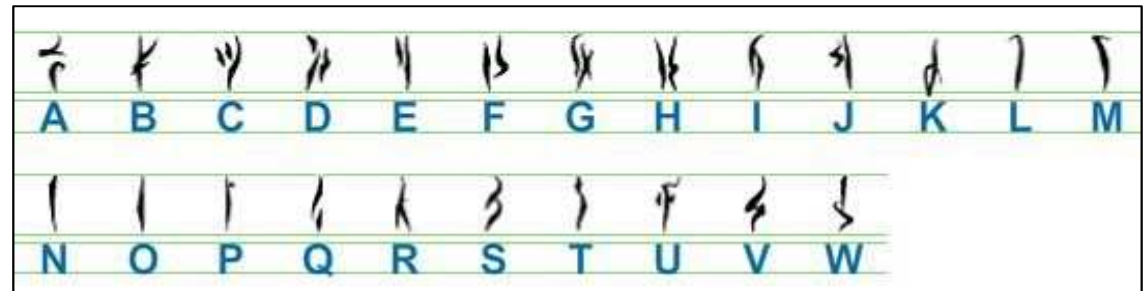

## SCRABBLE (NEDERLANDS)

Letter	Punten	Aantal	Letter	Punten	Aantal	Letter	Punten	Aantal	Letter	Punten	Aantal	Letter	Punten	Aantal
A	1	6	G	3	3	M	3	3	S	2	5	Y	8	1
B	3	2	H	4	2	N	1	10	T	2	5	(IJ)	(4)	(2)
C	5	2	I	1	4	O	1	6	U	4	3	Z	4	2
D	2	5	J	4	2	P	3	2	V	4	2	Blanco	0	2
E	1	18	K	3	3	Q	10	1	W	5	2			
F	4	2	L	3	3	R	2	5	X	8	1			

### SITH PROPHECY

N	⌋	L	7	Y	X	L	7	W	K
A	B	C	D	E	F	G	H	I	J
W	L	7	X	W	W	7	7	W	T
K	L	M	N	O	P	Q	R	S	T
W	I	C	M	i	T				
U	V	W	X	Y	Z				
7	7	A	7	3	7	5	7	7	7
1	2	3	4	5	6	7	8	9	0
E	7	'	7	7	7	7	7	7	7
,	;	:	.	?	!	'	'	"	"
(	)	{	}	[	]	7	7	<	>
(	)	{	}	[	]	\	/	<	>
7	7	'	7	X	F	7	7	-	7
+	-	=	%	#	\$	@	&	-	*
7	7	7	7						
	`	^	~						

### VULCANSRIPT

A	B	C	D	E	F	G	H	I	J	K	L	M
N	O	P	Q	R	S	T	U	V	W	X	Y	Z





































### TRADE FEDERATION

JL	3	6	4	11	11	3	JL	7	3	4	J	K
A	B	C	D	E	F	G	H	I	J	K	L	M
JK	6	7	4	6	11	7	11	3	JL	6	4	4
N	O	P	Q	R	S	T	U	V	W	X	Y	Z
6	1	11	3	3	11	11	11	3	4	,	.	
0	1	2	3	4	5	6	7	8	9	,	.	







































### LORD OF THE RINGS

9	6	6	6	6	6	6	6
a	e	i	o	u	y	x	yr
9	6	6	6	6	6	6	6
c	k	q	g	h	j	t	th
9	6	6	6	6	6	6	6
b	p	d	t	r	s	rh	ch
9	6	6	6	6	6	6	6
f	v	w	l	m	n	ae	ai



















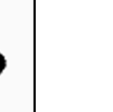





















## DROID

												
A	B	C	D	E	F	G	H	I	J	K	L	M
												
N	O	P	Q	R	S	T	U	V	W	X	Y	Z
												
0	1	2	3	4	5	6	7	8	9			

## NAL-HUTTESE

												
A	B	C	D	E	F	G	H	I	J	K	L	M
												
N	O	P	Q	R	S	T	U	V	W	X	Y	Z
												
0	1	2	3	4	5	6	7	8	9	#	\$	

## MORSEIRDE CODE

D 32 H 0020	D 64 H 0040	@	D 97 H 0061	a	D 98 H 0062	b	D 99 H 0063	c	D 100 H 0064	d	D 101 H 0065	e	D 102 H 0066	f	D 103 H 0067	g	D 104 H 0068	h		
																				
D 105 H 0069	i	D 106 H 006A	j	D 107 H 006B	k	D 108 H 006C	l	D 109 H 006D	m	D 110 H 006E	n	D 111 H 006F	o	D 112 H 0070	p	D 113 H 0071	q	D 114 H 0072	r	
																				
D 115 H 0073	s	D 116 H 0074	t	D 117 H 0075	u	D 118 H 0076	v	D 119 H 0077	w	D 120 H 0078	x	D 121 H 0079	y	D 122 H 007A	z					
																				

TERESIAN



MINBARI



CTHULHUAIN FONT



THEROPODA

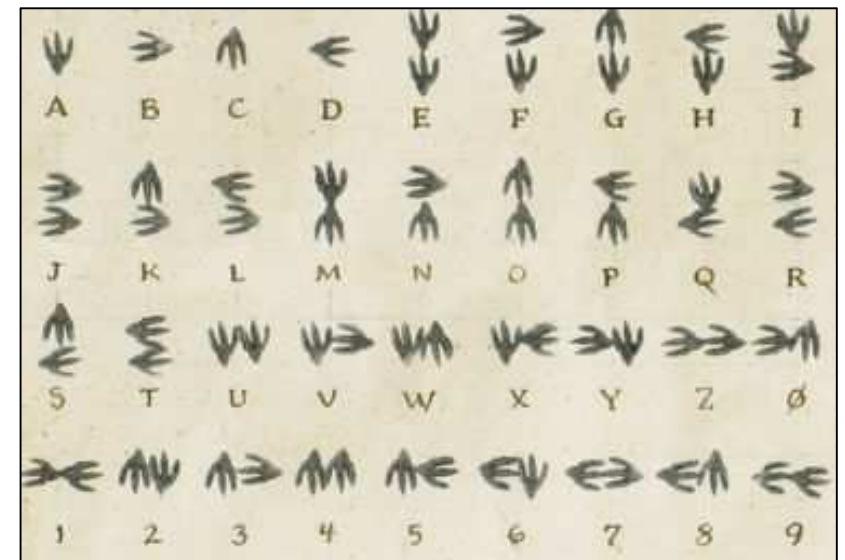



# BOEKEN ALFABET

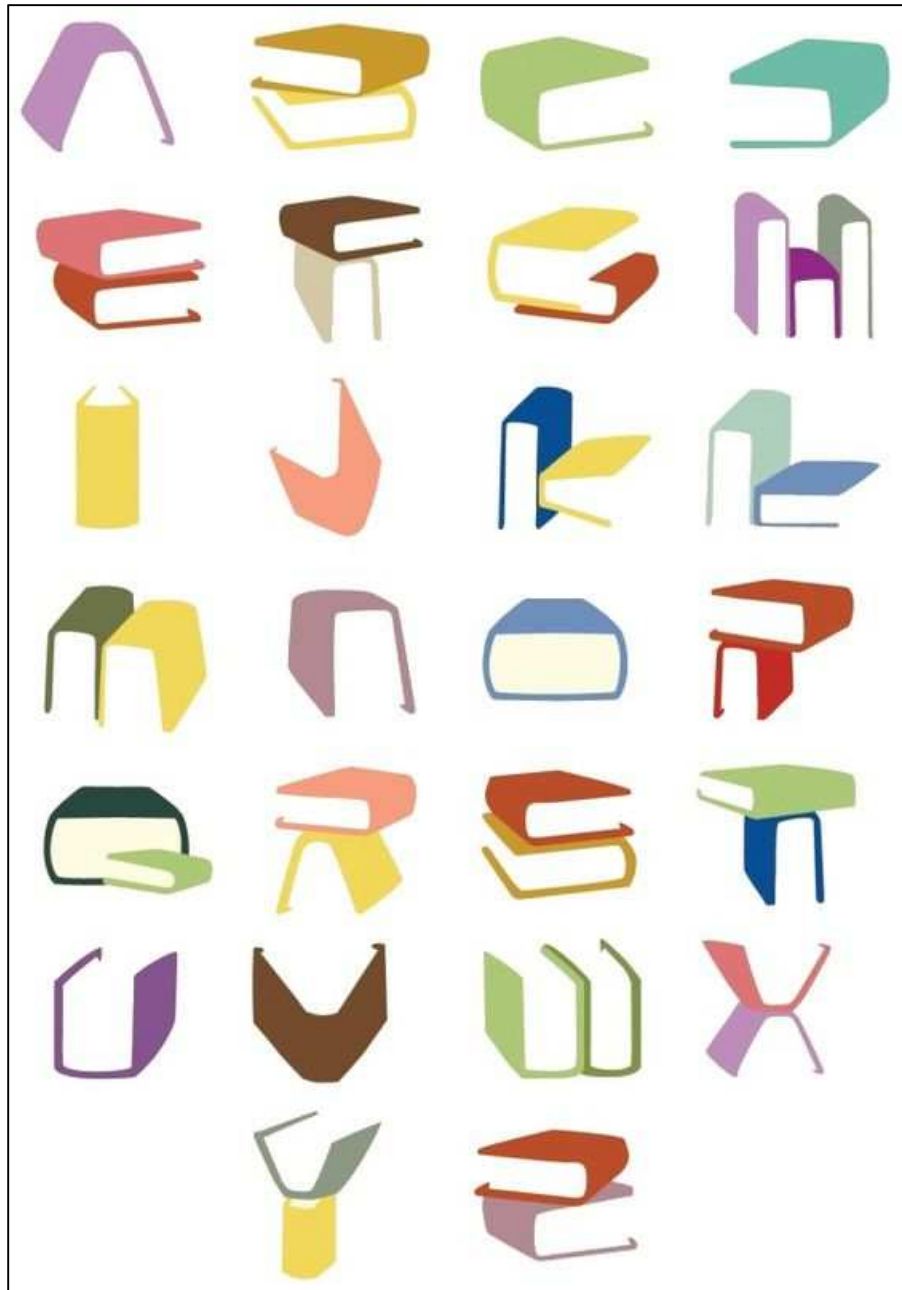

A	I	U	E	O	H	K	G	S	Z	C	X	J	Q	T
⋈	∩	∪	∪	∪	∩	∩	∩	∩	∩	∩	∩	∩	∩	∩
D	N	F	V	P	B	M	L	R	Y	W	y	n	AI	EI
∩	∩	∩	∩	∩	∩	∩	∩	∩	∩	∩	∩	∩	∩	∩
AA	II	UU	EE	OO	yA	y	yE	yO						
⋈	∩	∪	∪	∪	∩	∩	∩	∩						
yAA	yU	yEE	yOO	-W	-O	-L	-E	-Q						
⋈	∪	∪	∪	∩	∩	∩	∩	∩						

## ANCIENT PRIMES

⋈	∩	∩	∩	∩	∩	∩	∩	∩	∩	∩	∩	∩	∩	∩
A	B	C	D	E	F	G	H	I	J	K	L	M		
∩	∩	∩	∩	∩	∩	∩	∩	∩	∩	∩	∩	∩	∩	∩
N	O	P	Q	R	S	T	U	V	W	X	Y	Z		





# THAI ALPHABET

a	b	c	d	e	f	g	h	i
ก	ข	ค	ด	เด	ฟ	ง	ห	อ
j	k	l	m	n	o	p	q	r
จ	ก	ล	ม	น	อ	ป	ด	ร
s	t	u	v	w	x	y	z	
ส	ต	น	บ	ผ	ห	ย	ซ	

0	1	2	3
๐	๑	๒	๓
4	5	6	7
๔	๕	๖	๗
8	9		
๘	๙		

a	b	c	d	e	f	g	h	i
ก	ข	ค	ด	เด	ฟ	ง	ห	อ
j	k	l	m	n	o	p	q	r
จ	ก	ล	ม	น	อ	ป	ด	ร
s	t	u	v	w	x	y	z	
ส	ต	น	บ	ผ	ห	ย	ซ	

# ILYTHIIRI ALPHABET

I	II	III	IV
1	2	3	4
๑	๒	๓	๔
5	6	7	8
๕	๖	๗	๘
9	10	11	12
๙	๑๐	๑๑	๑๒
13	14	15	16
๑๓	๑๔	๑๕	๑๖
17	18	19	20
๑๗	๑๘	๑๙	๒๐
21	22	23	24
๒๑	๒๒	๒๓	๒๔

ELITE ALPHABET



ANCIENT QUILL

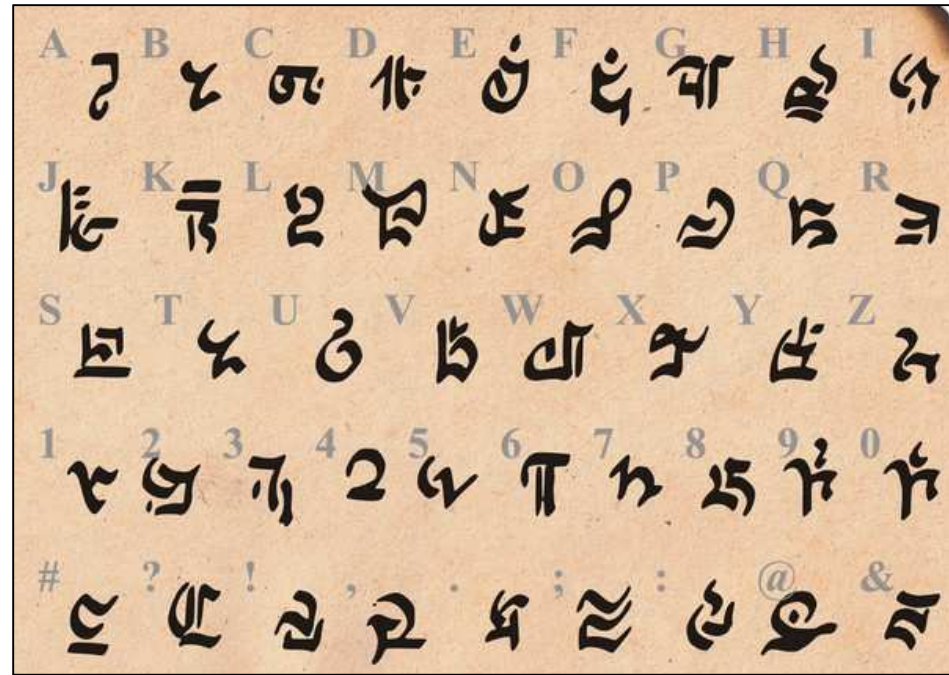

GLAGOLJICA ALPHABET



UNITOLOGY



SHORTHAND (ENGELS)

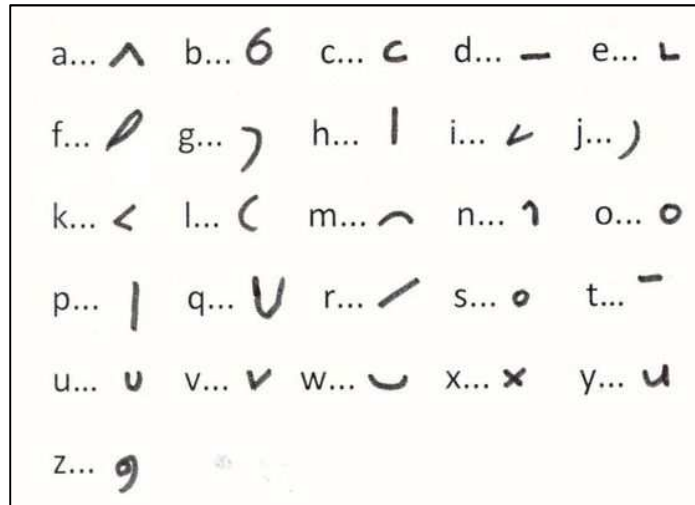

## HALO FORERUNNER SYMBOLS

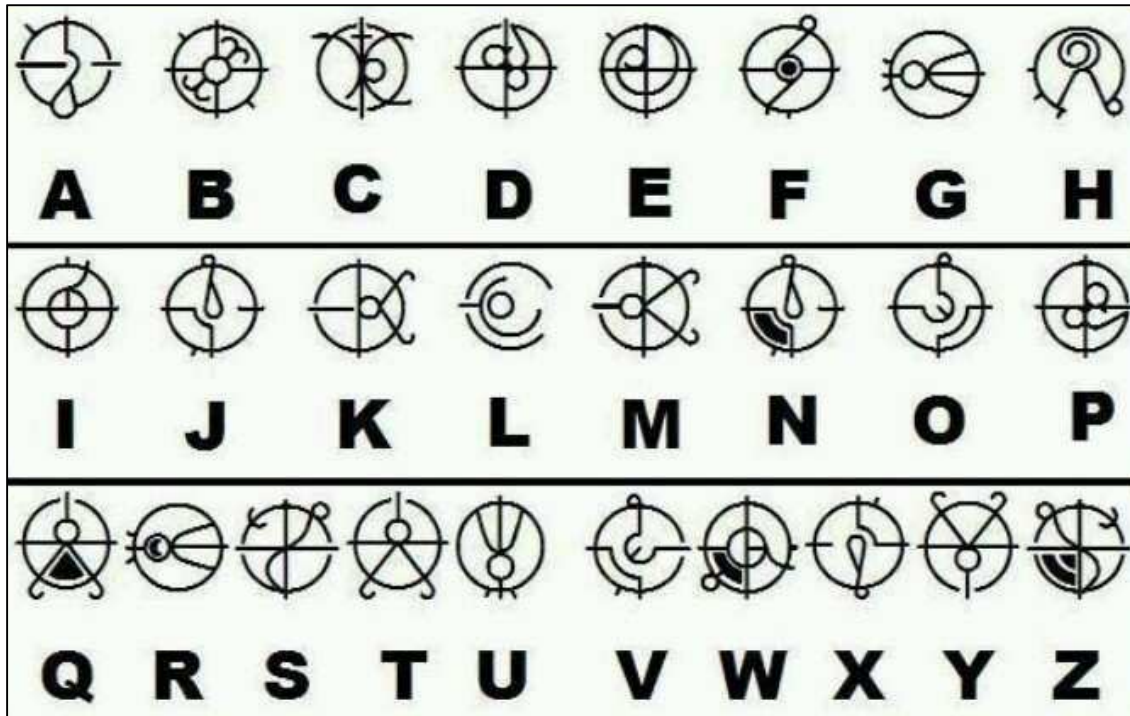

## LEGEND OF ZELDA

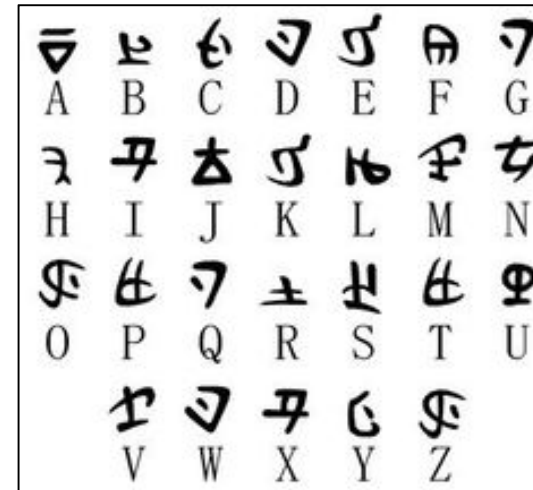

## MALACHIM ALPHABET 2

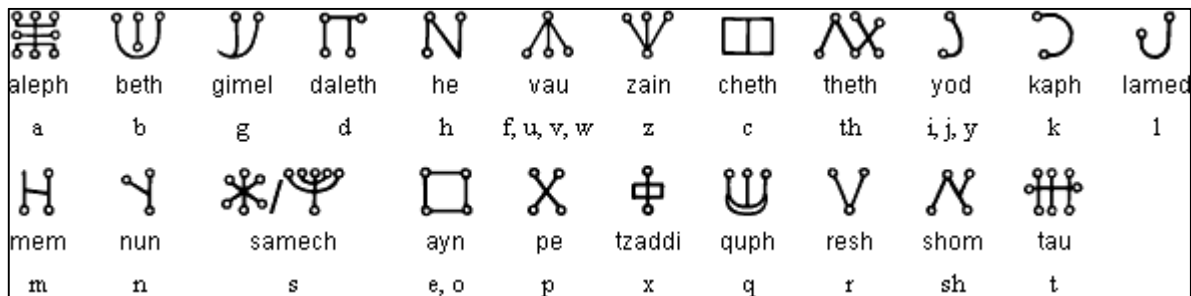

## XR ALPHABET

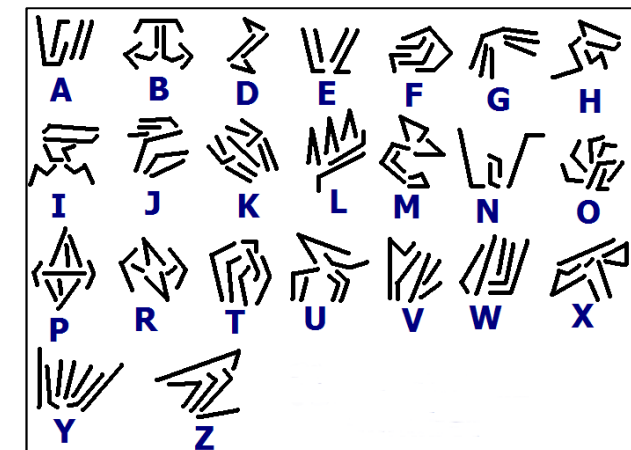

### MASAFUMI'S ALPHABET

	A		J		S
	B		K		T
	C		L		U
	D		M		V
	E		N		W
	F		O		X
	G		P		Y
	H		Q		Z
	I		R		

○	0	3	4	8	8
X	1	7	5	2	9
L	2	5	6		
≡	3	4	7		

### MAGE'S ALPHABET

A		K		u	
B		L		v	
C		M		w	
D		N		x	
E		O		y	
F		P		z	
G		Q			
H		R			
I		S			
J		T			

### TREE ALPHABET

Beith		B	Birch
Luis		L	Rowan
Fearn		F	Alder
Saille		S	Willow
Duin		D	Ash
huathe		H	Hawthorn
Duir		D	Oak
Cinne		C	Holly
Coll		C	Hazel
Quert		Q	Apple
Muin		M	Vine
Cort		C	Lvy
Ngetal		N	Reed
Straif		S	Blackthorn
Ruis		R	Elder
Ailim		A	Pine
Ohn		O	Corse
Ur		U	Heather
Eadha		E	Poplar
loho		L	Yew

### PRECURSOR ALPHABET

A	B	C	D	E	F	G	H	I
J	K	L	M	N	O	P	Q	R

S	T	U	V	W	X	Y	Z

“Medieval style”

“Asian style”

“Rune style”

p	b	t	d	k	g
Ʒ	Ɔ	ʒ	Ɔ	Ɔ	Ɔ
f	θ	s	ʃ	x	h
Ʒ	Ɔ	Ɔ	Ɔ	Ɔ	Ɔ
v	ð	z	ʒ	j	u
Ʒ	Ɔ	Ɔ	Ɔ	Ɔ	Ɔ

p	b	t	d	k	g
Ɔ	Ɔ	Ɔ	Ɔ	Ɔ	Ɔ
f	θ	s	ʃ	x	h
Ɔ	Ɔ	Ɔ	Ɔ	Ɔ	Ɔ
v	ð	z	ʒ	j	u
Ɔ	Ɔ	Ɔ	Ɔ	Ɔ	Ɔ

p	b	t	d	k	g
Ɔ	Ɔ	Ɔ	Ɔ	Ɔ	Ɔ
f	θ	s	ʃ	x	h
Ɔ	Ɔ	Ɔ	Ɔ	Ɔ	Ɔ
v	ð	z	ʒ	j	u
Ɔ	Ɔ	Ɔ	Ɔ	Ɔ	Ɔ

m	n	l	r
Ɔ	Ɔ	Ɔ	Ɔ

m	n	l	r
Ɔ	Ɔ	Ɔ	Ɔ

m	n	l	r
Ɔ	Ɔ	Ɔ	Ɔ

a:	e:	i:	o:	u:
Ɔ	Ɔ	Ɔ	Ɔ	Ɔ

a:	e:	i:	o:	u:
Ɔ	Ɔ	Ɔ	Ɔ	Ɔ

a:	e:	i:	o:	u:
Ɔ	Ɔ	Ɔ	Ɔ	Ɔ

a	e	i	o	u
Ɔ	Ɔ	Ɔ	Ɔ	Ɔ

a	e	i	o	u
Ɔ	Ɔ	Ɔ	Ɔ	Ɔ

a	e	i	o	u
Ɔ	Ɔ	Ɔ	Ɔ	Ɔ

0	1	2	3	4
Ɔ	Ɔ	Ɔ	Ɔ	Ɔ

0	1	2	3	4
Ɔ	Ɔ	Ɔ	Ɔ	Ɔ

0	1	2	3	4
Ɔ	Ɔ	Ɔ	Ɔ	Ɔ

5	6	7	8	9
Ɔ	Ɔ	Ɔ	Ɔ	Ɔ

5	6	7	8	9
Ɔ	Ɔ	Ɔ	Ɔ	Ɔ

5	6	7	8	9
Ɔ	Ɔ	Ɔ	Ɔ	Ɔ



### CIRCULAR GALLIFREYAN

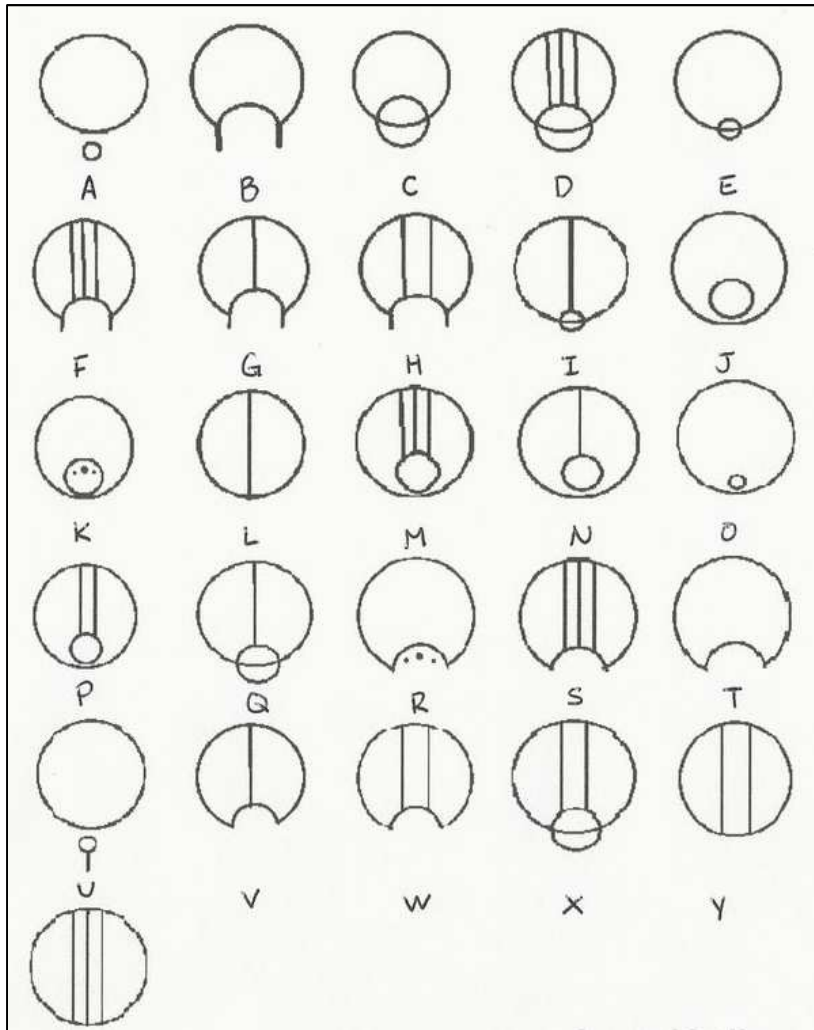

### VESPERIAN ALPHABET

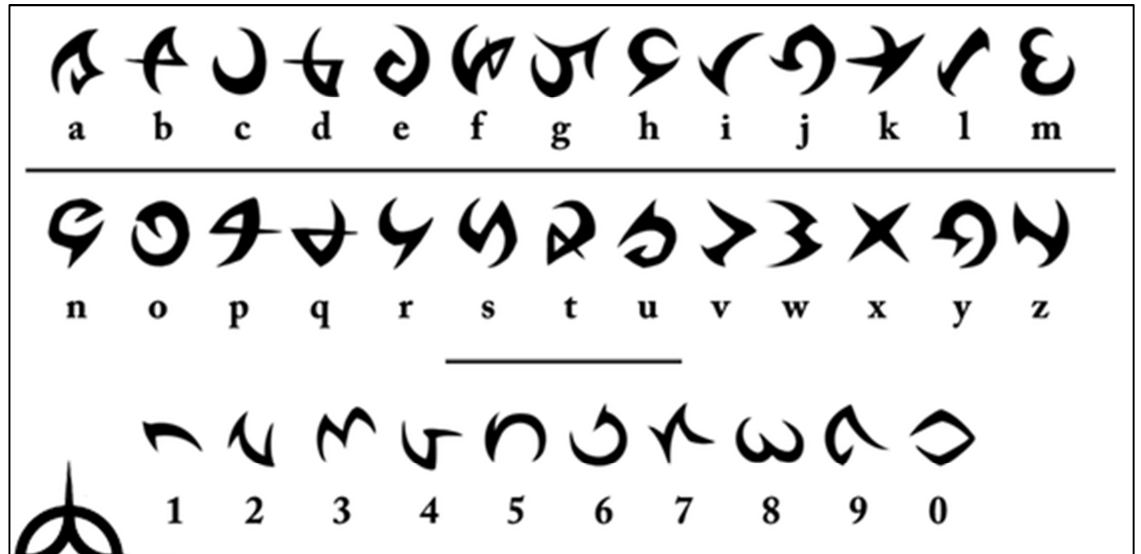

### ZORAN ALPHABET

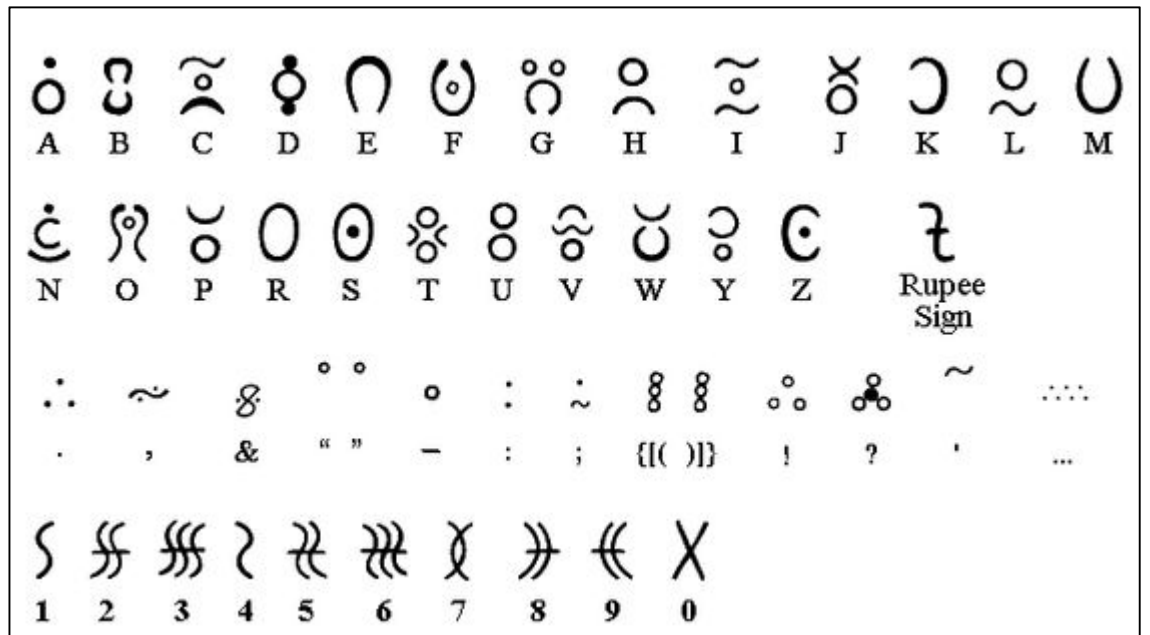



KING WEN HEXAGRAM SEQUENCE  
CONVENANT  
PROTO SINAITISCH  
ALCHEMIE  
KITTAT  
AIRCRAFT MARSHALLING SIGNALS  
MOTORCYCLE SIGNALS  
MOBILE CRANE HAND SIGNALS  
CRANE SIGNALS  
BASIC MILITARY HAND SIGNALS  
MILITARY HAND SIGNALS  
ALTITUDE INDICATOR  
SECTION AND PLATOON FIELD SIGNALS  
FOOTBALL REFEREE SIGNALS  
BASKETBALL REFEREE SIGNALS  
CRICKET UMPIRE HAND SIGNALS  
VOLLEYBALL SIGNALS (NFHS)  
RED HERRING  
JURERING TURNEN  
BROEKENCODE  
BARCODES  
BLORK ALFABET  
COMMON SITH  
DOTSIES ALPHABET  
MAYAN  
OUDE SYMBOLEN / SMEEDIJZEREN HEK

POKEMON  
RIDDERS EN JONKVROUWEN  
GEONOSIAN  
SCRABBLE (NEDERLANDS)  
SITH PROPHECY  
TRADE FEDERATION  
LORD OF THE RINGS  
VULCANSRIPT  
DROID  
NAL-HUTTESE  
MORSEIRDE CODE  
TERESIAN  
MINBARI  
CTHULHUAIN FONT  
THEROPODA  
BOEKEN ALFABET  
ANCIENT PRIMES  
NAGA ALPHABET  
ELEMENTARIUM  
ILLUMINATI CODE  
EXTRA GALACTIC ALPHABET  
MONGOLIAN ALPHABET & NUMERALS  
ALPHABET OF ANGELS  
ANGELOID RUNES  
THAI ALPHABET  
ILYTHIIRI ALPHABET

ELITE ALPHABET  
ANCIENT QUILL  
GLAGOLJICA ALPHABET  
UNITOLOGY  
SHORTHAND (ENGELS)  
HALO FORERUNNER SYMBOLS  
LEGEND OF ZELDA  
MALACHIM ALPHABET 2  
XR ALPHABET  
MASAFUMI'S ALPHABET  
MAGE'S ALPHABET  
TREE ALPHABET  
PRECURSOR ALPHABET  
CIRCULAR GALLIFREYAN  
VESPERIAN ALPHABET  
ZORAN ALPHABET  
MALACHIM FONT  
ALCHEMICAL



Farvekode i RJ45 stik

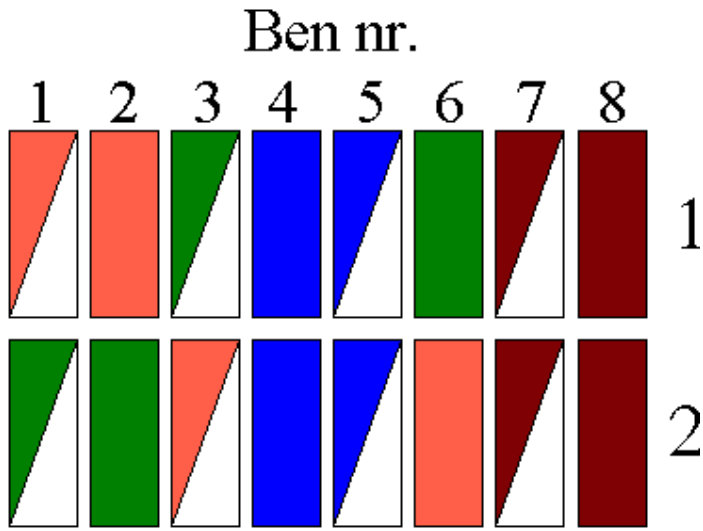

The Voodoo Code



A B C D E F G



H I J K L M N

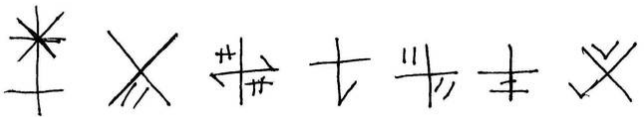

O P Q R S T U

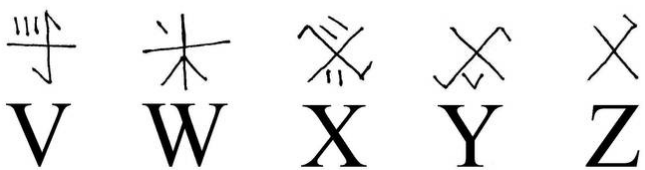

Bog-alfabet

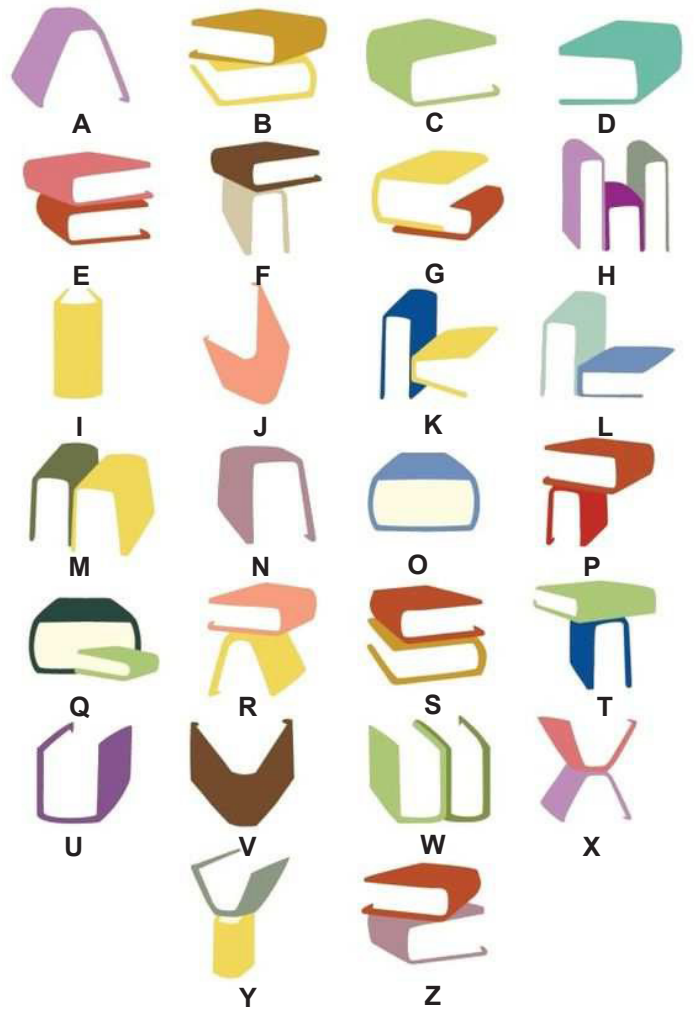

Jak And Daxter; Precursor Alphabet

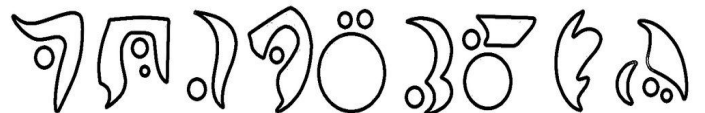

A B C D E F G H I



J K L M N O P Q R



S T U V W X Y Z

# Steinheil 1837

## Steinheil (1837)

a	∴	h	∴∴	s	∴∴	3	∴∴
b	∴∴	i,j	•	sch	∴∴	4	∴∴
c,k	∴•	l	∴∴	t	∴•	5	∴∴
ch	∴∴∴	m	∴∴	u,v	∴•	6	∴∴
d	∴•	n	∴∴	w	∴∴	7	∴∴
e	•	o	∴∴	z	∴∴	8	∴∴
f	∴∴	p	∴∴∴	1	∴∴∴	9	∴∴
g	∴∴	r	∴∴	2	∴∴∴	0	∴∴

# Meteorologiske symboler - skyinddeling

	0	1	2	3	4	5	6	7	8	9
C <sub>H</sub>										
C <sub>M</sub>										
C <sub>L</sub>										